

1-18 GHz WIDE BAND AMPLIFIER GaAs Monolithic Microwave IC

Description

The CHA3023 is a travelling wave amplifier using cascode FET. It is designed for a wide range of applications.

The circuit is manufactured with a PHEMT process of 0.25µm gate length, via holes through the substrate and air bridges and it is available in die form.

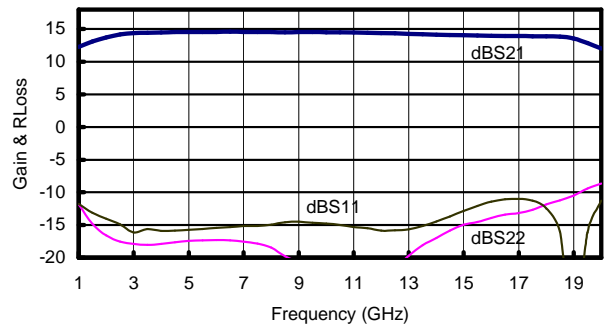
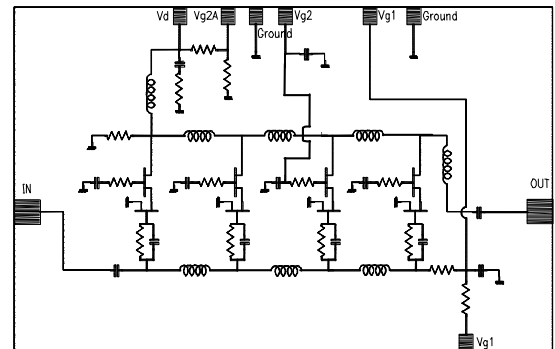

On wafer measurements

Main Features

- Broadband performances : 1-18 GHz
- 14dB gain
- 3dB typical Low Noise Figure
- ±0.7 dB gain flatness
- Die size : 2.15 X 1.42 X 0.10 mm

Main Characteristics

Tamb. = 25°C

Symbol	Parameter	Min	Typ	Max	Unit
Fop	Operating frequency range	1		18	GHz
G	Small signal Gain	12.5	14		
NF	Noise figure			4	dB
Id	Bias current		95		mA

ESD Protection : Electrostatic discharge sensitive device. Observe handling precautions !

Electrical Characteristics for Broadband Operation

Tamb = +25°C, Vd=5V,

Vg1=-0.3V tuned to have Id=95mA

Vg2=+2V

Symbol	Parameter	Min	Typ	Max	Unit
Fop	Operating frequency range	1		18	GHz
G	Small signal gain F= 1 to 3GHz F= 3 to 18GHz	11.5 12.5	13 14		dB dB
ΔG	Small signal gain flatness		± 0.7		dB
P1dB	Output power at 1dB gain compression	15	17		dBm
VSWRin	Input VSWR		2.2:1		
VSWRout	Output VSWR		2.2:1		
NF	Noise Figure F= 1 to 4GHz F= 1 to 18GHz		4 2.5	6 4	dB dB
Vdc	DC voltage Vd Vg1 Vg2		+5 -0.3 +2		V V V
Id	Bias current		95		mA

Absolute Maximum Ratings

Tamb. = 25°C (1)

Symbol	Parameter	Min.	Max.	Unit
Vd	Drain to ground bias voltage	0	6.5	V
Id	Drain current		110	mA
Vg1	Gate to ground bias voltage	-1.5	0.3	V
Vg2	Gate to ground bias voltage	0	3	V
Pin	Maximum peak input power overdrive (2)		+15	dBm
Pin	Maximum input CW power		+10	dBm
Top	Operating temperature	-40	85	°C
Tstg	Storage temperature range	-55	125	°C

(1) Operation of this device above any one of these parameters may cause permanent damage

(2) Duration < 1s

Typical Results

Chip Typical Response (On wafer Sij) :

Tamb = +25°C

Vd = 5.0V ; Vg2 = 2V and Vg1 tuned to Id = 95mA

Freq GHz	MS11 dB	PS11 °	MS12 dB	PS12 °	MS21 dB	PS21 °	MS22 dB	PS22 °
1,00	-11,84	-86,69	-68,86	12,95	12,27	175,21	-11,75	175,50
1,50	-14,88	-96,63	-59,00	-65,50	13,11	164,60	-13,13	134,72
2,00	-16,59	-102,61	-57,76	-85,24	13,74	152,90	-14,05	103,57
2,50	-17,55	-106,89	-55,88	-101,83	14,21	140,45	-14,93	77,53
3,00	-17,90	-110,67	-56,09	-133,36	14,38	127,54	-16,15	60,98
3,50	-18,04	-114,80	-54,51	-146,60	14,42	116,64	-15,59	48,79
4,00	-17,90	-119,10	-53,45	-166,51	14,50	105,01	-15,88	36,69
4,50	-17,64	-124,04	-52,07	178,88	14,55	93,81	-15,86	24,61
5,00	-17,43	-129,21	-52,57	165,06	14,56	82,83	-15,73	15,78
5,50	-17,36	-134,92	-50,96	155,03	14,57	71,87	-15,62	6,63
6,00	-17,32	-140,65	-49,52	145,22	14,57	61,00	-15,45	-1,24
6,50	-17,35	-146,35	-48,93	131,37	14,59	50,26	-15,32	-9,98
7,00	-17,55	-152,20	-48,40	115,97	14,58	39,44	-15,18	-16,89
7,50	-17,83	-157,72	-47,52	106,26	14,57	28,65	-15,15	-23,44
8,00	-18,45	-162,53	-46,94	95,20	14,56	17,95	-14,94	-30,10
8,50	-19,80	-164,62	-46,12	84,24	14,54	7,35	-14,56	-35,12
9,00	-20,69	-168,37	-45,55	74,79	14,55	-3,41	-14,48	-41,40
9,50	-21,89	-169,76	-44,84	62,64	14,55	-14,27	-14,67	-46,03
10,00	-23,72	-166,34	-44,04	53,09	14,53	-25,14	-14,80	-51,30
10,50	-25,53	-158,58	-43,80	39,38	14,50	-36,02	-14,99	-53,99
11,00	-26,70	-141,85	-43,12	26,47	14,48	-46,99	-15,32	-57,64
11,50	-25,89	-122,93	-42,27	14,98	14,44	-57,87	-15,48	-58,42
12,00	-24,09	-110,31	-41,97	2,10	14,40	-68,96	-15,87	-59,30
12,50	-21,74	-106,76	-41,35	-12,13	14,35	-79,91	-15,80	-58,07
13,00	-19,70	-104,76	-41,15	-24,23	14,29	-90,92	-15,65	-56,60
13,50	-18,11	-106,18	-40,87	-38,14	14,23	-101,96	-15,16	-55,31
14,00	-17,00	-112,34	-40,38	-49,23	14,17	-112,98	-14,47	-55,03
14,50	-15,86	-116,67	-40,14	-64,35	14,11	-124,02	-13,71	-56,11
15,00	-14,97	-120,58	-39,83	-75,76	14,05	-135,10	-12,85	-58,60
15,50	-14,53	-124,94	-39,66	-88,72	14,01	-146,32	-12,09	-63,04
16,00	-13,93	-128,81	-39,29	-102,25	13,97	-157,55	-11,44	-69,64
16,50	-13,43	-132,05	-38,83	-118,12	13,93	-168,97	-11,06	-77,10
17,00	-13,18	-134,80	-38,87	-127,14	13,92	179,41	-11,02	-85,48
17,50	-12,67	-137,46	-38,86	-144,06	13,92	167,15	-11,28	-95,81
18,00	-11,85	-137,37	-37,71	-156,10	13,91	154,49	-12,47	-109,17
18,50	-11,23	-139,77	-37,48	-170,79	13,84	140,84	-16,01	-125,94
19,00	-10,46	-143,04	-37,24	175,70	13,57	125,81	-32,15	-109,28
19,50	-9,39	-147,86	-36,76	157,84	12,86	111,51	-16,15	-15,25
20,00	-8,65	-153,32	-36,48	142,87	12,02	99,83	-11,25	-34,96

Chip Typical Response (On wafer measurements) :

Tamb = +25°C

Vd = 5.0V ; Vg2 = 2V and Vg1 tuned to Id = 95mA

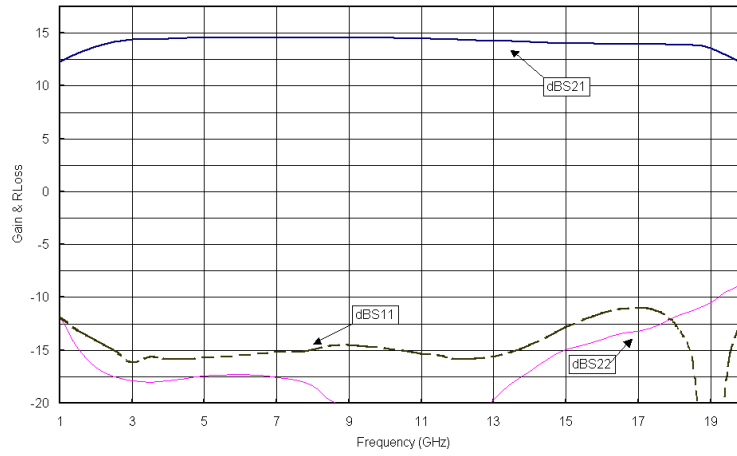

Typical on wafer S parameters

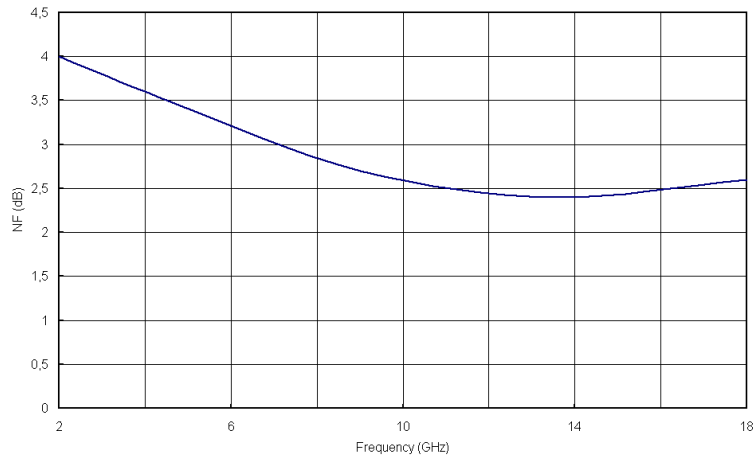

Typical on wafer Noise Figure

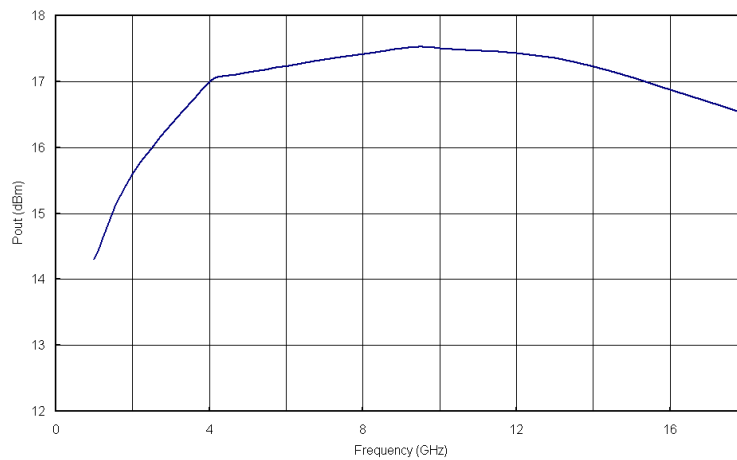

Pout vs Frequency (Pin=4dBm)

Chip Typical Response (Test Jig measurements) :

Tamb = +25°C

Vd = 5.0V ; Vg2 = 2V and Vg1 tuned to Id = 95mA

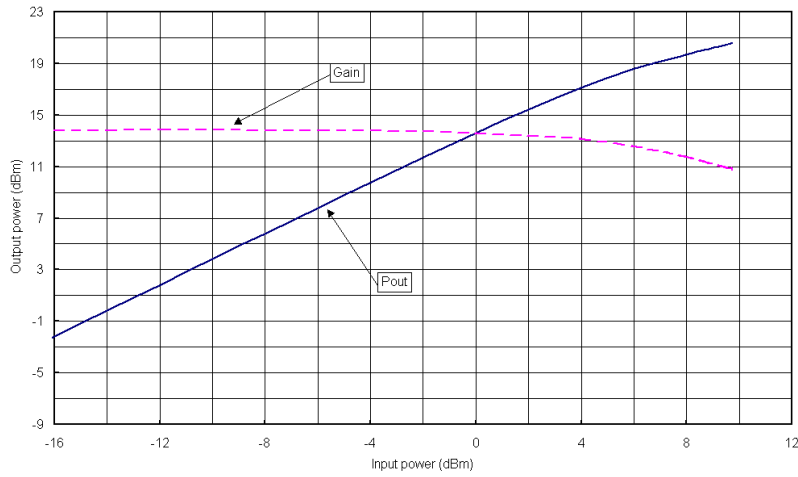

Power compression @ 1GHz

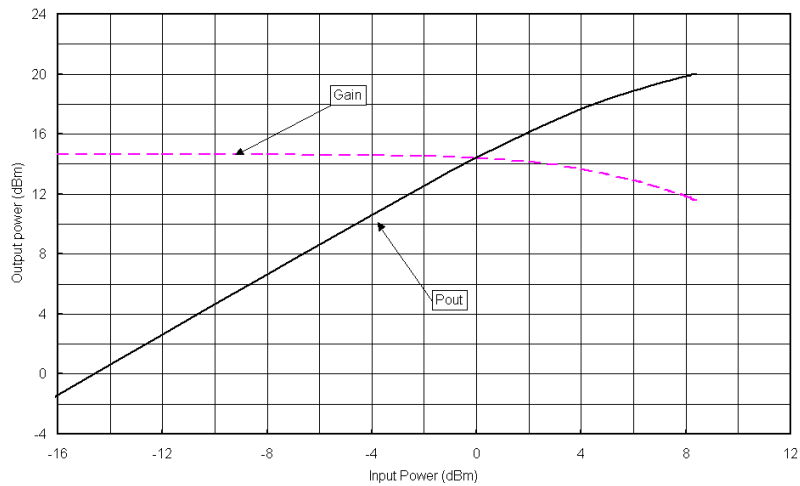

Power compression @ 12GHz

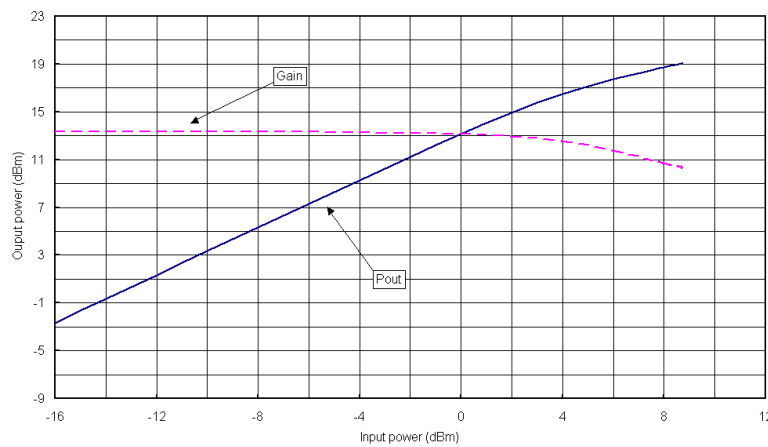

Power compression @ 18GHz

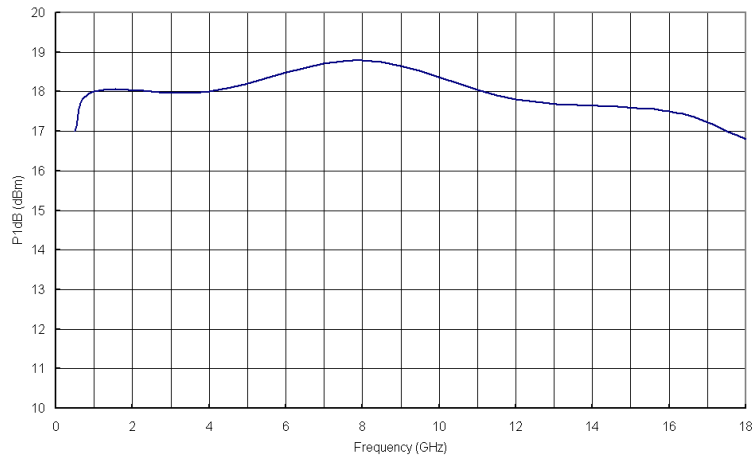

P1dB vs Frequency

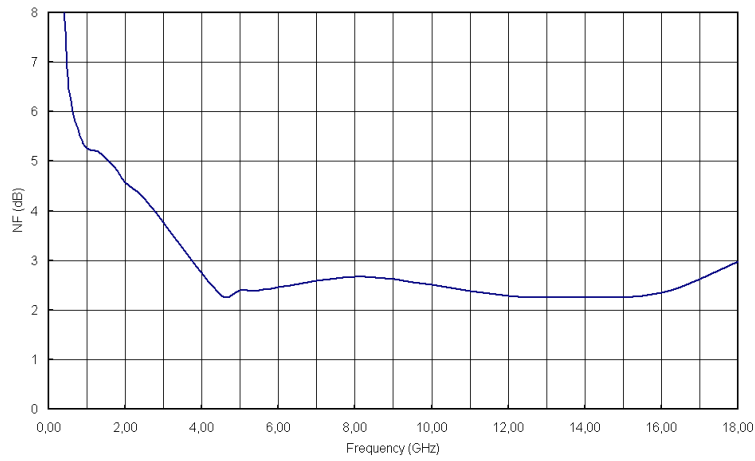

Noise Figure vs Frequency

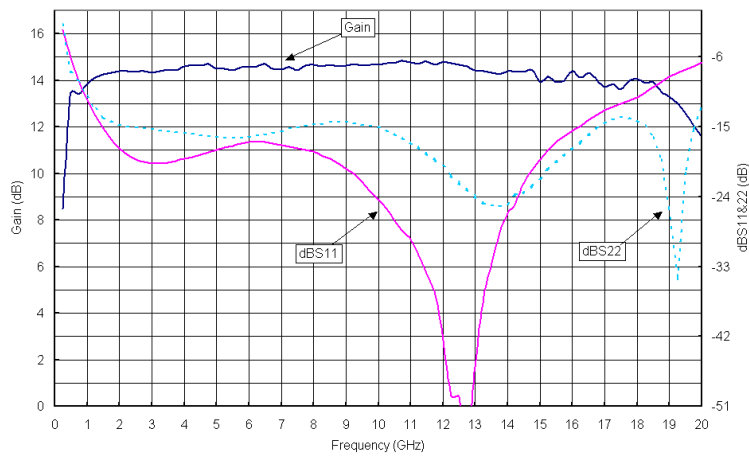

Gain & Return Loss vs Frequency

Chip Assembly and Mechanical Data

Special care should be taken concerning the biasing procedure. Apply V_g before V_d .

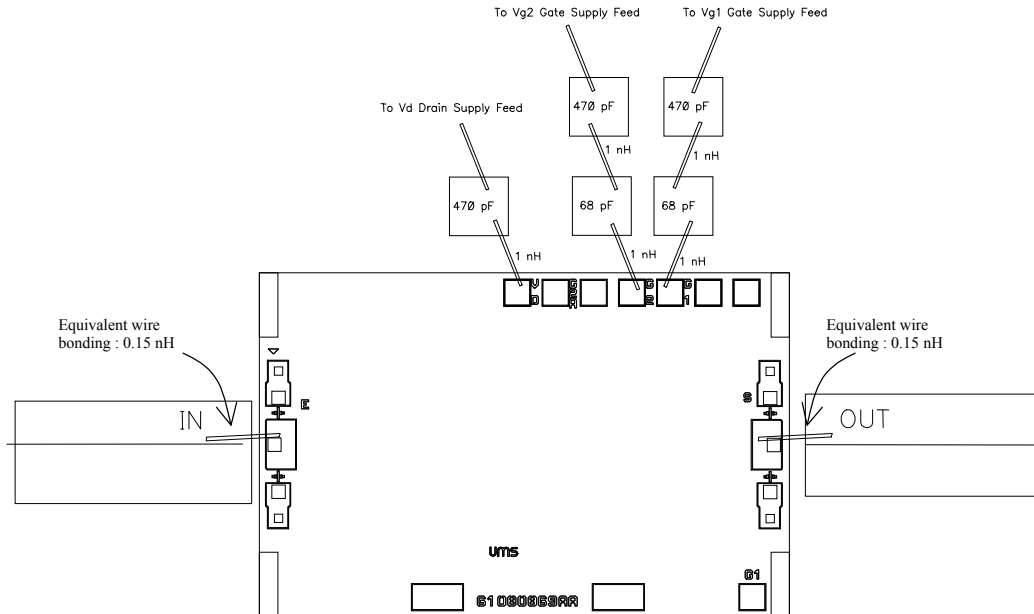

The CHA3023 could be used without V_{g2} bias. There is a resistor bridge inside the chip. This one generates the correct value of V_{g2} Bias. Pads G2a and G2 must be connected. Equivalent RF Wire Bondings: 0.15 nH (typical length of 200 μ m for a 25 μ m diameter wire).

