

31-40GHz Variable Gain Amplifier

GaAs Monolithic Microwave IC in SMD package

Description

The CHA3694-QDG is a variable gain broadband three-stage monolithic amplifier. It is designed for a wide range of applications, typically commercial communication systems. The circuit is manufactured with a Power pHEMT process, 0.15µm gate length, via holes through the substrate and air bridges.

It is available in lead-free SMD package.

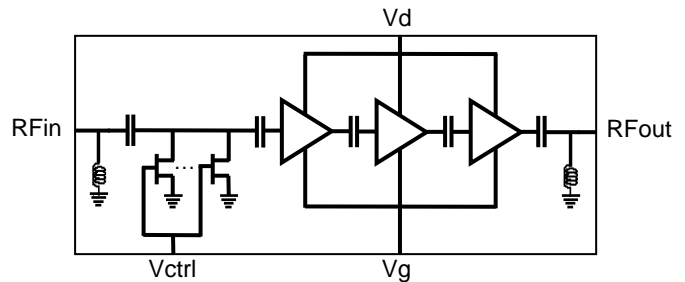

Main Features

- Broadband performance 31-40GHz
- 18dB gain
- 25dBm output IP3
- 19dB gain control range
- 24L-QFN4x4
- ESD protected
- MSL level : 1

Main Characteristics

Tamb = +25°C, Vd = +3.5V

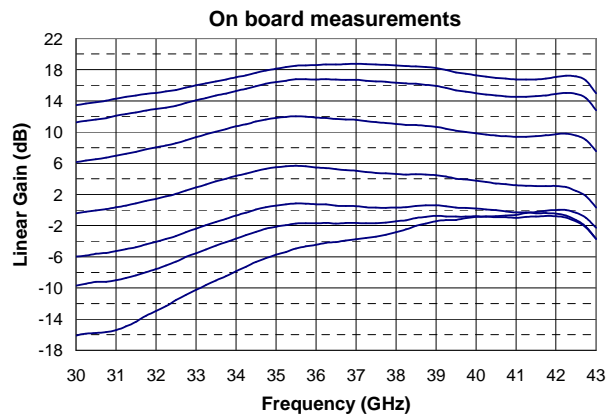

Symbol	Parameter	Min	Typ	Max	Unit
Fop	Operating frequency range	31		40	GHz
G	Small signal gain		18		dB
Gc	Gain control range		19		dB
OIP3	Output 3 rd order intercept point @ max. gain		25		dBm

ESD Protections: Electrostatic discharge sensitive device. Observe handling precautions!

Electrical Characteristics

Tamb = +25°C, Vd = +3.5V

Symbol	Parameter	Min	Typ	Max	Unit
Fop	Operating frequency range	31		40	GHz
G	Nominal gain @ max. gain (Vctrl=-1.5V) (31-34GHz)	13	15		dB
	Nominal gain @ max. gain (Vctrl=-1.5V) (34-40GHz)	16	18		dB
NF	Noise figure @ max. gain (31-37GHz)		11	13	dB
	Noise figure @ max. gain (37-40GHz)		9	11	dB
RLin	Input Return loss (any attenuation) (31-37GHz)		-4	-3	dB
	Input Return loss (any attenuation) (37-40GHz)		-7	-6	dB
RLout	Output Return loss (any attenuation) (31-37GHz)		-7	-6	dB
	Output Return loss (any attenuation) (37-40GHz)		-5	-4	dB
OIP3	Output 3 rd order intercept point @ nominal gain	23	25		dBm
P1dB	Output power at 1dB gain compression @ nominal gain	15	17		dBm
Gc	Gain control range (31-34GHz)	23	25		dB
	Gain control range (37-40GHz)	17	19		dB
Vd	Drain bias voltage		3.5		V
Id	Drain bias current *	120	160	200	mA
Id P1dB	Drain current at 1dB gain compression		180		mA
Vg	Gate bias voltage		-1		V
Vctrl	Variable gain control voltage	-1.5		+0.6	V

* Id not affected by Vctrl.

These values are representative of onboard measurements as defined on the drawing in paragraph "Evaluation mother board".

Absolute Maximum Ratings (1)

Tamb = +25°C

Symbol	Parameter	Values	Unit
Vd	Maximum drain bias voltage	4	V
Id	Maximum quiescent bias current	200	mA
Vg	Gate bias voltage	-4.0 to +0.8	V
Vctrl	Variable gain control voltage	-2.5 to +0.8	V
Pin	Maximum RF input power overdrive @ 3.5V	5	dBm
Tch	Maximum channel temperature	175	°C
Ta	Operating temperature range	-40 to +85	°C
Tstg	Storage temperature range	-55 to +125	°C

(1) Operation of this device above anyone of these parameters may cause permanent damage.

Device thermal performances:

All the figures given in this section are obtained assuming that the QFN device is cooled down only by conduction through the package thermal pad (no convection mode considered).

The temperature is monitored at the package back-side interface (T_{case}) as shown below. The system maximum temperature must be adjusted in order to guarantee that T_{case} remains below than the maximum value specified in the next table. So, the system PCB must be designed to comply with this requirement.

A derating must be applied on the dissipated power if the T_{case} temperature can not be maintained below than the maximum temperature specified (see the curve $P_{diss. Max}$) in order to guarantee the nominal device life time (MTTF).

DEVICE THERMAL SPECIFICATION : CHA3694-QDG		
Recommended max. junction temperature (T_j max)	:	151 °C
Junction temperature absolute maximum rating	:	175 °C
Max. continuous dissipated power @ $T_{case} = 85$ °C	:	0,56 W
=> P_{diss} derating above $T_{case}^{(1)} = 85$ °C	:	9 mW/°C
Junction-Case thermal resistance ($R_{th J-C}^{(2)}$)	:	<117 °C/W
Min. package back side operating temperature ⁽³⁾	:	-40 °C
Max. package back side operating temperature ⁽³⁾	:	85 °C
Min. storage temperature	:	-55 °C
Max. storage temperature	:	125 °C

(1) Derating at junction temperature constant = T_j max

(2) $R_{th J-C}$ is calculated for a worst case where the **hotter junction** of the MMIC is considered.

(3) T_{case} = Package back side temperature measured under the die-attach-pad (see the drawing below).

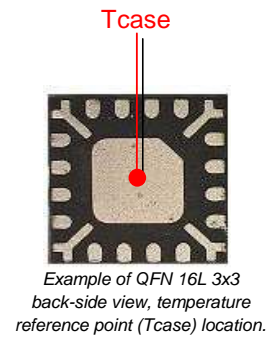
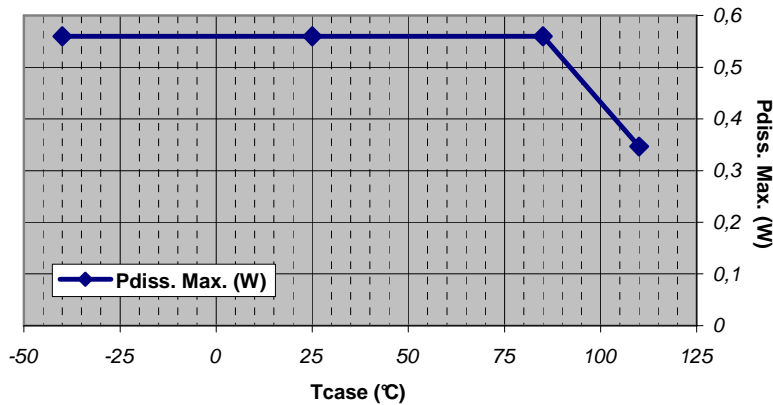

Typical Package Sij parameters for Vctrl=-1.5V:

Tamb = +25°C, Vd = +3.5V, Id = 160mA

Freq (GHz)	dB(S11)	Ph(S11) (°)	dB(S12)	Ph(S12) (°)	dB(S2 1)	Ph(S21) (°)	dB(S22)	Ph(S22) (°)
2,0	-0,4	144	-51,6	-41	-54,8	-83	-4,7	122
3,0	-0,4	127	-49,2	-58	-48,2	-25	-6,5	147
4,0	-0,5	109	-48,4	-104	-45,3	-90	-1,1	119
5,0	-0,6	89	-49,8	-137	-46,0	-147	-1,2	85
6,0	-2,3	67	-52,4	-169	-42,3	103	-2,5	60
7,0	-1,1	64	-53,0	167	-38,2	-52	-3,7	40
8,0	-0,8	42	-52,8	130	-32,5	-99	-4,8	20
9,0	-0,9	22	-53,7	93	-24,8	-146	-6,5	3
10,0	-1,0	2	-55,0	54	-17,7	152	-8,2	-5
11,0	-1,1	-19	-57,2	27	-12,7	85	-7,6	-11
12,0	-1,3	-41	-59,1	-28	-9,4	20	-6,3	-27
13,0	-1,7	-64	-62,0	-55	-6,9	-43	-5,3	-48
14,0	-2,2	-88	-65,5	-168	-5,0	-102	-4,4	-69
15,0	-3,2	-115	-56,7	-168	-3,5	-159	-3,7	-91
16,0	-5,5	-144	-52,8	121	-2,1	147	-3,2	-112
17,0	-11,0	-172	-52,0	77	-1,0	93	-2,9	-133
18,0	-21,5	-112	-50,2	71	-0,2	42	-2,9	-153
19,0	-10,8	-93	-50,3	62	0,7	-5	-3,1	-174
20,0	-7,1	-115	-47,9	41	2,1	-49	-3,6	164
21,0	-5,6	-137	-48,8	14	4,1	-96	-4,5	138
22,0	-4,9	-157	-52,7	2	6,4	-146	-6,1	109
23,0	-4,8	-174	-54,3	21	8,5	159	-8,3	71
24,0	-5,0	170	-48,9	20	10,0	101	-10,9	24
25,0	-5,2	157	-47,1	32	10,8	43	-12,4	-32
26,0	-5,3	146	-46,0	2	11,3	-13	-11,5	-82
27,0	-5,2	135	-43,5	-6	11,6	-65	-10,4	-122
28,0	-5,3	123	-43,8	-19	12,1	-117	-9,2	-155
29,0	-5,4	112	-42,6	-34	12,7	-169	-8,0	175
30,0	-5,7	103	-41,4	-59	13,5	137	-7,0	145
31,0	-5,3	95	-41,0	-86	14,3	84	-6,9	114
31,5	-4,7	89	-45,1	-127	14,7	56	-6,9	101
32,0	-4,3	82	-53,4	-150	15,0	28	-7,4	85
32,5	-4,3	75	-57,5	49	15,4	1	-8,4	74
33,0	-4,1	70	-45,2	-30	16,0	-27	-9,2	65
33,5	-3,8	61	-43,5	-20	16,5	-56	-10,8	56
34,0	-3,5	53	-42,4	-52	17,0	-86	-12,7	50
34,5	-3,5	42	-42,6	-54	17,6	-116	-16,0	60
35,0	-3,5	31	-41,2	-60	18,1	-148	-17,0	94
35,5	-3,8	20	-39,5	-61	18,5	179	-13,2	106
36,0	-4,5	7	-37,5	-76	18,6	145	-10,5	100
36,5	-5,4	-5	-37,4	-82	18,7	112	-8,7	95
37,0	-6,7	-15	-38,5	-88	18,8	78	-7,2	89
37,5	-8,3	-27	-39,1	-104	18,7	44	-6,3	81
38,0	-10,4	-39	-39,0	-95	18,5	9	-6,0	70
38,5	-13,5	-45	-40,1	-100	18,4	-26	-5,7	63
39,0	-15,6	-47	-40,9	-106	18,2	-63	-5,4	56
39,5	-17,3	-41	-41,0	-111	17,7	-100	-5,5	45
40,0	-17,8	-34	-38,5	-94	17,3	-137	-5,4	34
41,0	-17,6	-81	-34,4	-109	16,8	147	-7,5	1
42,0	-18,1	-110	-30,5	-133	17,1	56	-10,9	-67
43,0	-7,3	-167	-29,1	173	15,0	-82	-11,9	161
44,0	-4,8	139	-35,2	121	-0,4	146	-7,9	170
45,0	-3,0	102	-43,2	73	-18,9	80	-3,2	134
46,0	-2,8	78	-46,5	160	-39,6	36	-2,4	110
47,0	-2,8	54	-38,7	-131	-36,8	-111	-1,8	95
48,0	-3,5	32	-34,0	-174	-30,0	-174	-1,7	81
49,0	-5,1	11	-30,6	140	-27,4	140	-1,5	62
50,0	-11,5	5	-28,5	83	-27,5	84	-2,4	38

The Sij measurement calibration planes are defined in the paragraph "Definition of the Sij reference planes".

Typical Measured Performances

Tamb = +25°C, Vd = +3.5V, Vg tuned for Id = 160 mA

Measurements in the package access plan, using the proposed land pattern & board, as defined in paragraph "Evaluation mother board:".

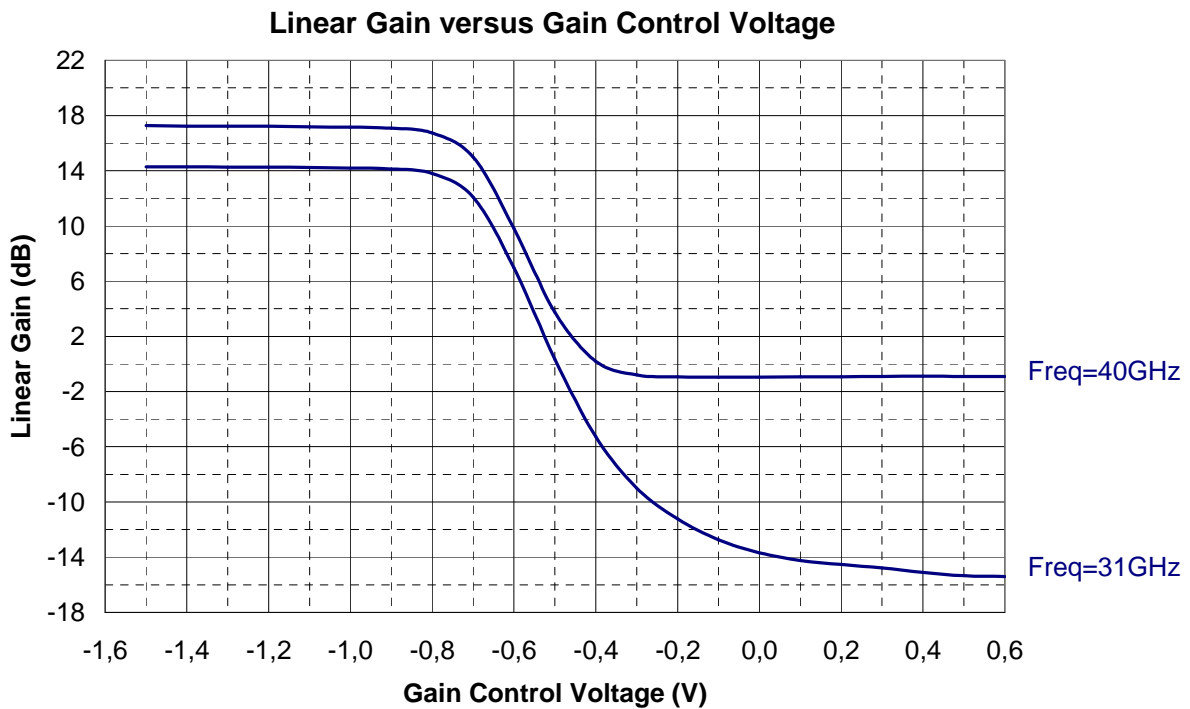
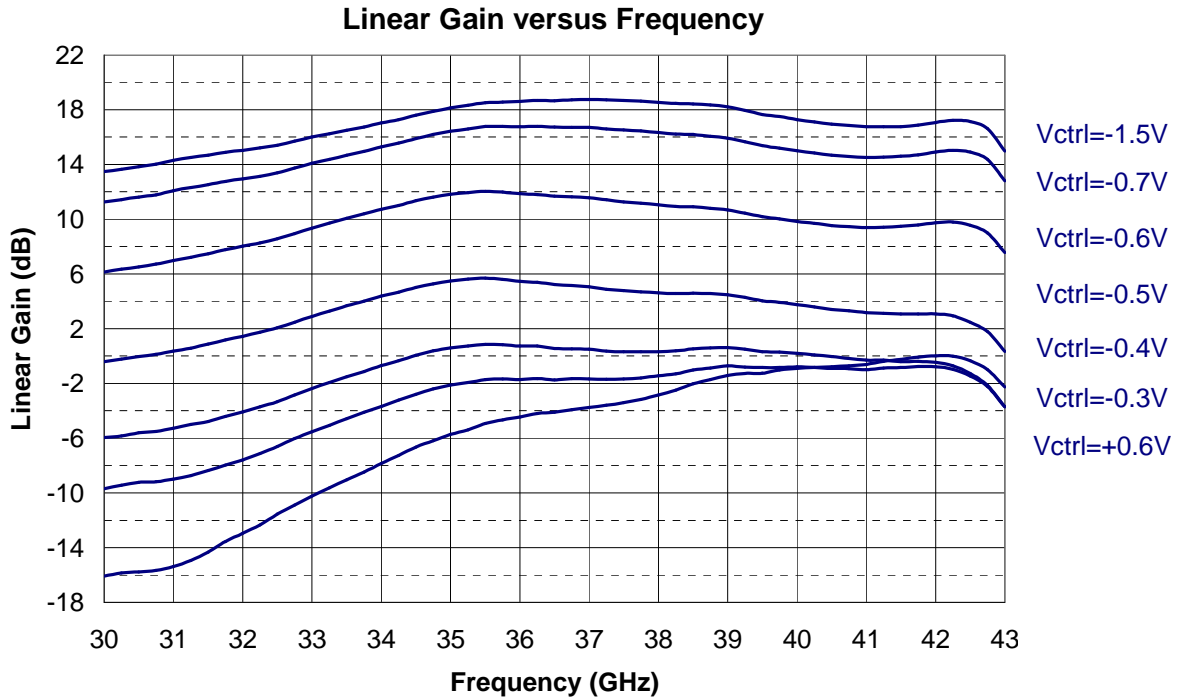

Gain Control Range versus Frequency

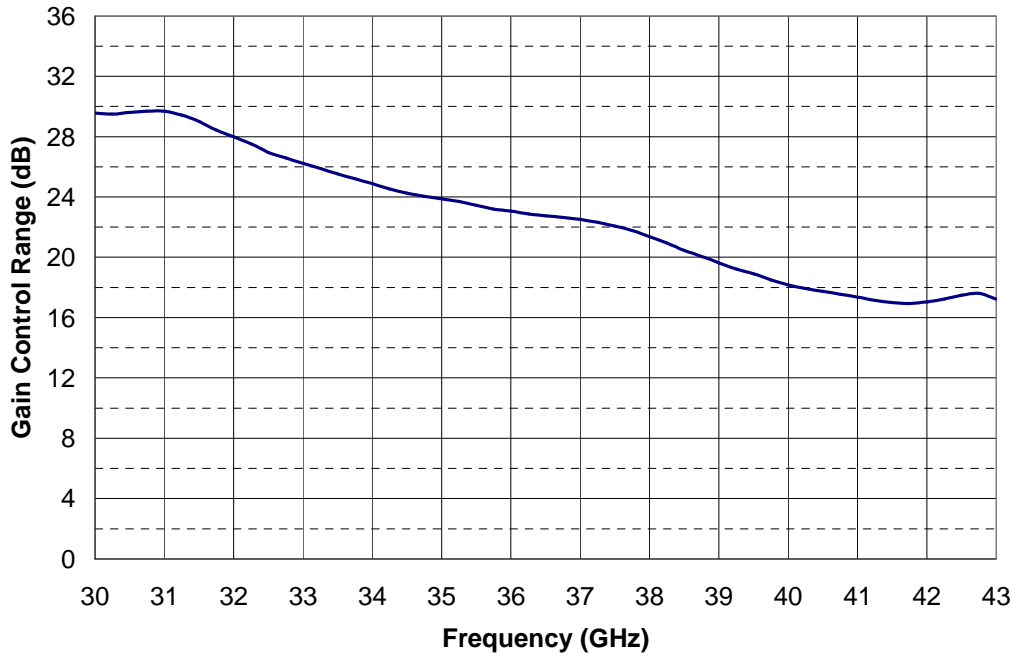

Return Losses versus Frequency and Gain Control Voltage

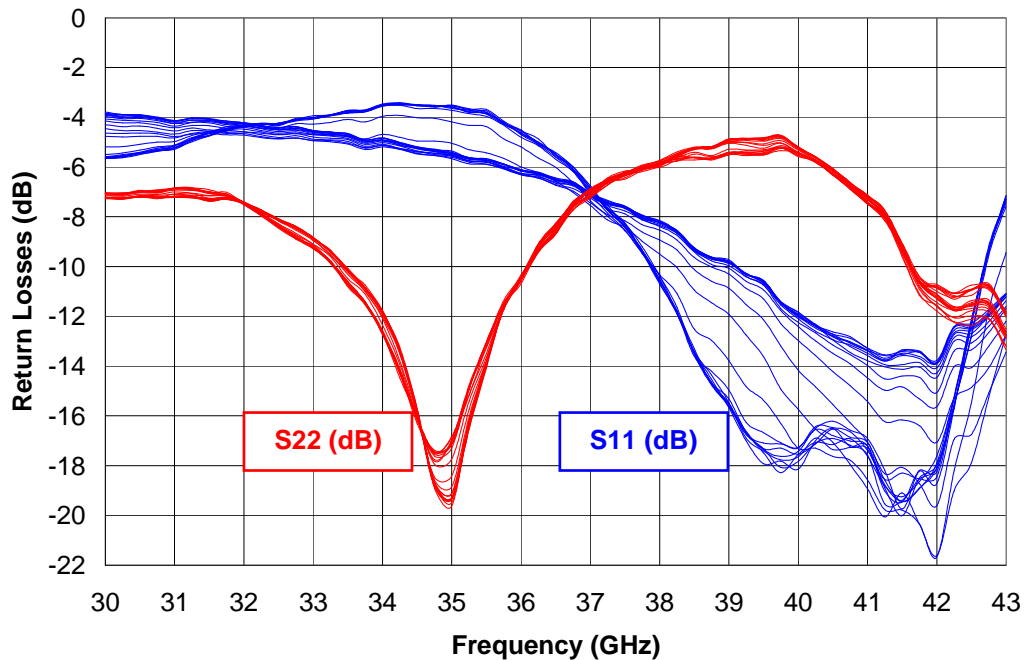

Typical Measured Performances

Tamb = +25°C, Vd = +3.5V, Vg tuned for Id = 160 mA

Measurements in the plan of the connectors, using the proposed land pattern & board, as defined in paragraph "Evaluation mother board:".

Output power and gain versus Vctrl and input power @ 31GHz

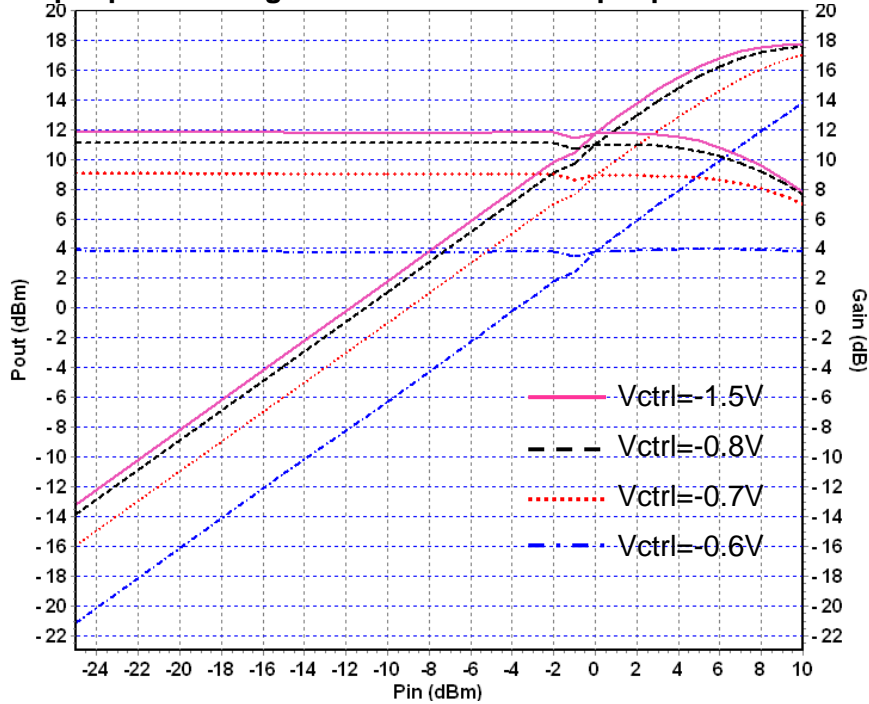

Output power and gain versus Vctrl and input power @ 35GHz

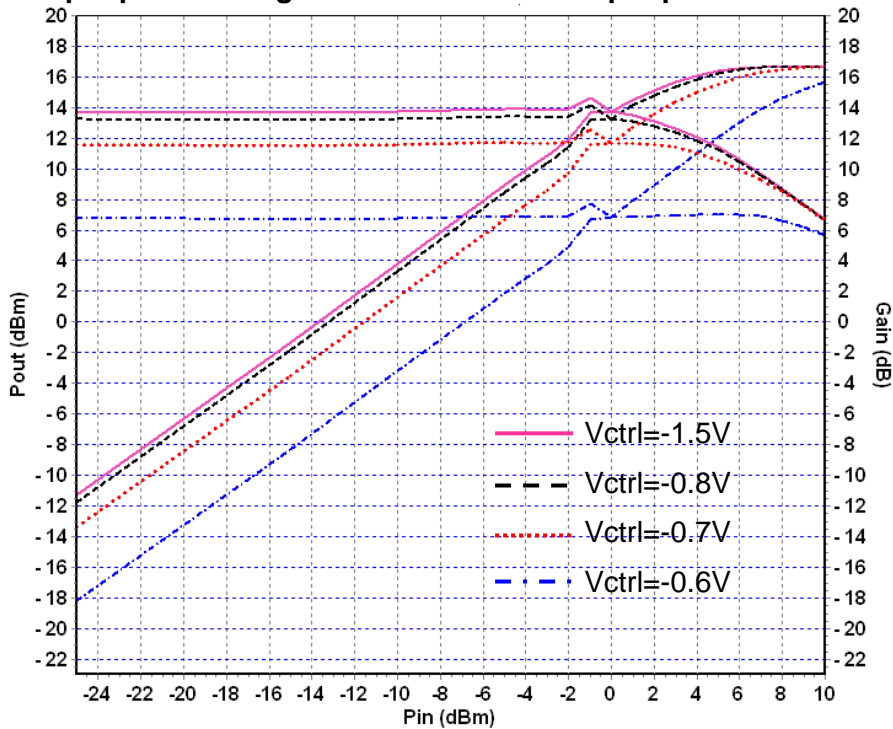

Output power and gain versus Vctrl and input power @ 40GHz

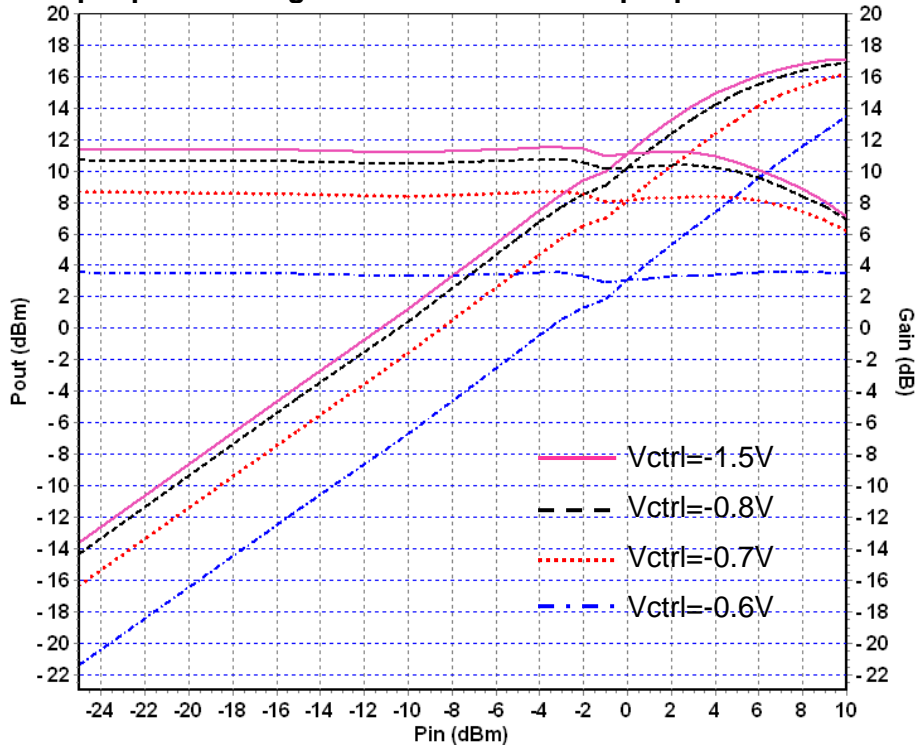

Output IP3 versus Dual Carrier Output Power for Nominal Gain @ 25°C

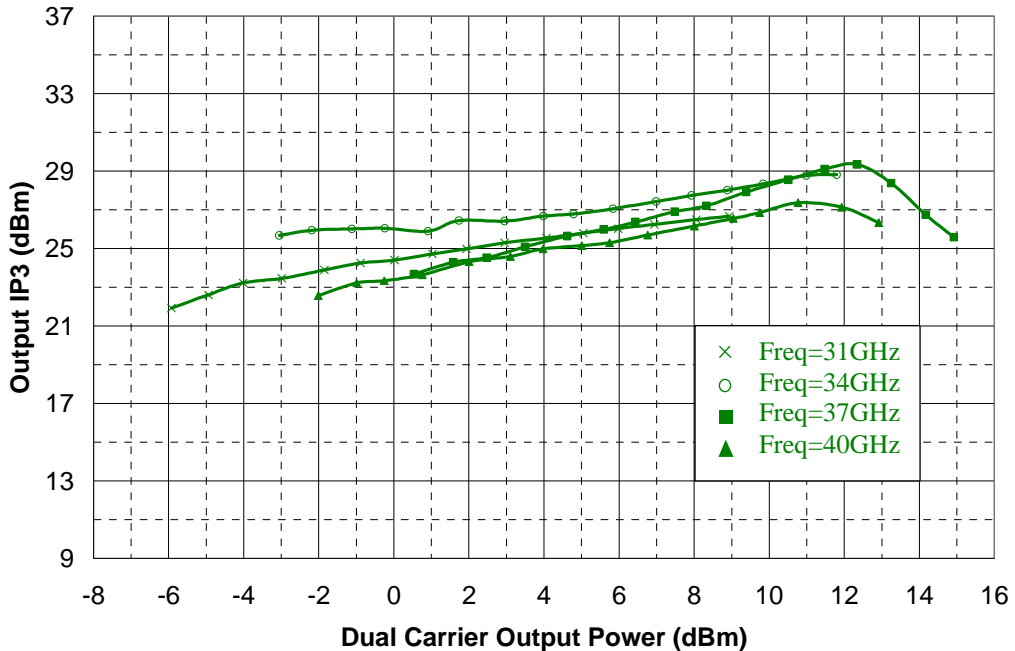

Typical Measured Performance in Temperature

T = -40°C, +25°C, +85°C, Vd = +3.5V, Vg tuned for Id = 160 mA

Measurements in the plan of the connectors, using the proposed land pattern & board, as defined in paragraph "Evaluation mother board:".

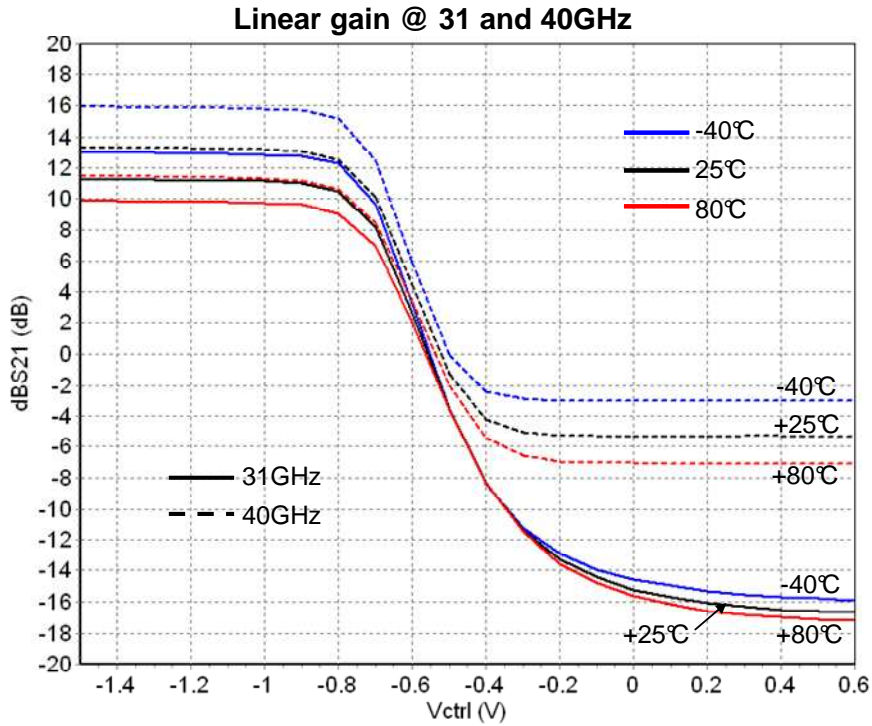

(Current search @ Vctrl=-1,5V @ 38-39GHz @ 25°C)

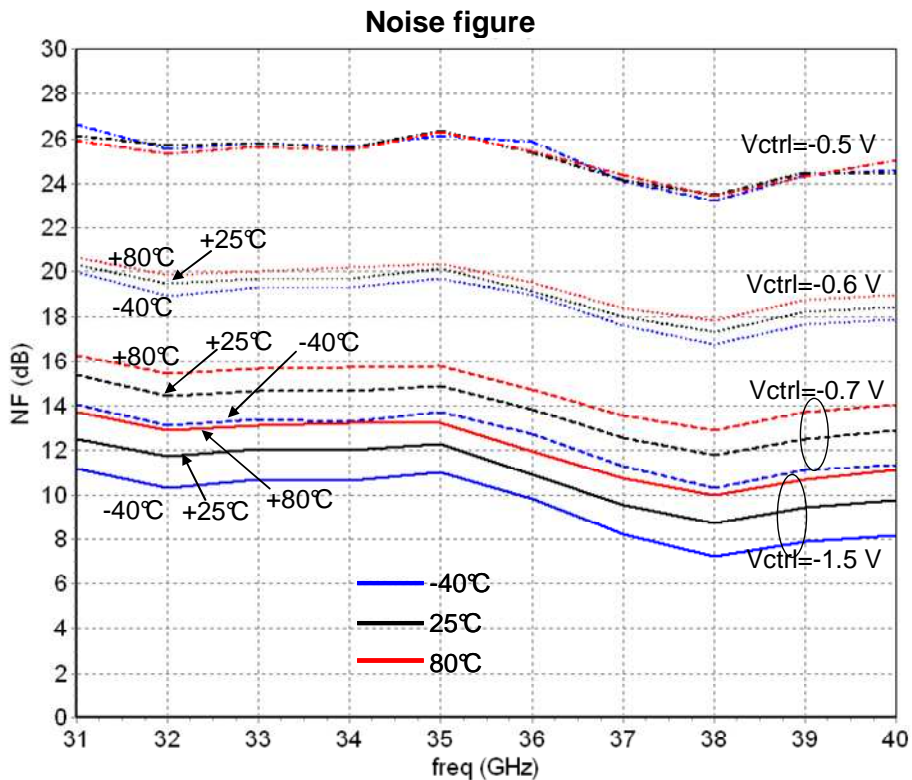

Output IP3 versus Dual Carrier Output Power for Nominal Gain @ 40GHz

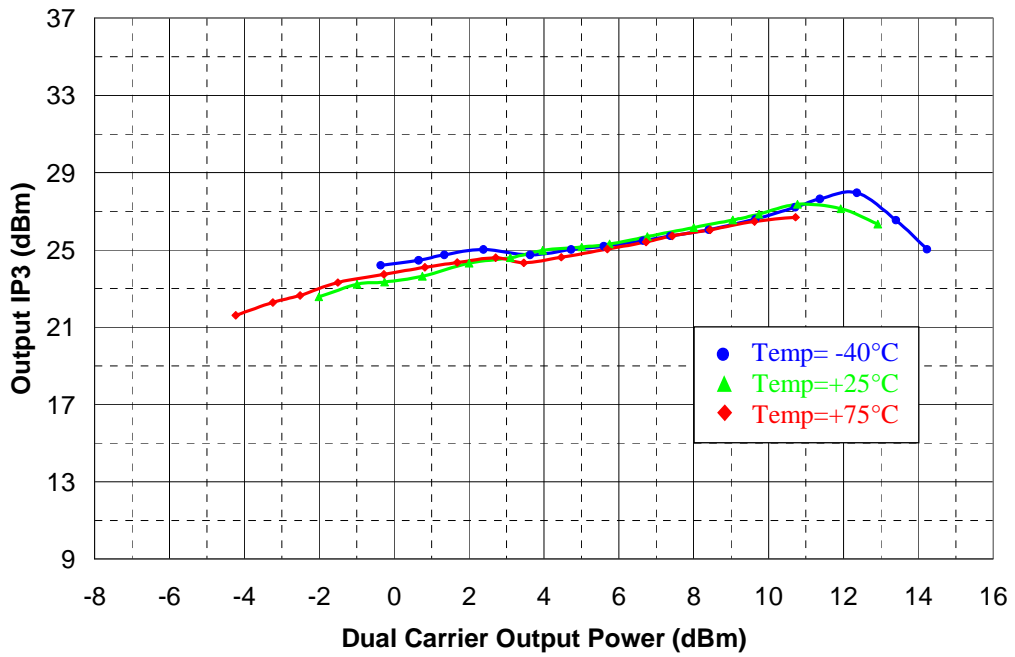

Package outline ⁽¹⁾

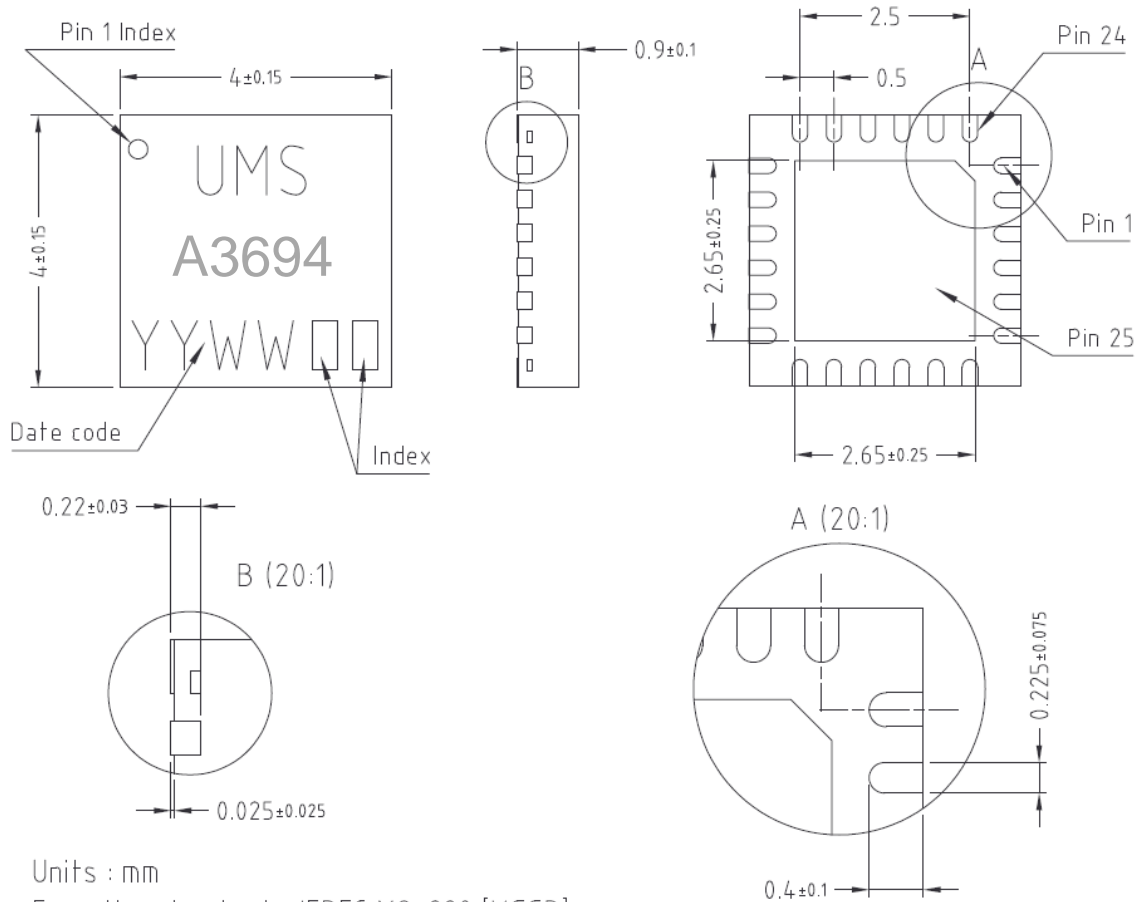

Units : mm

From the standard : JEDEC MO-220 [VGGD]

Matt tin, Lead free (Green)

Matt tin, Lead Free (Green)		1-	Nc	13-	Gnd
Units	mm	2-	Gnd	14-	Gnd
From the standard JEDEC MO-220 (VGGD)		3-	Gnd	15-	RF OUT
		4-	RF IN	16-	Gnd
25-	GND	5-	Gnd	17-	Gnd
		6-	Gnd	18-	Nc
		7-	Nc	19-	Nc
		8-	Nc	20-	Nc
		9-	Nc	21-	Vd
		10-	Vctrl	22-	Nc
		11-	Vg	23-	Nc
		12-	Nc	24-	Nc

⁽¹⁾The package outline drawing included to this data-sheet is given for indication. Refer to the application note AN0017 available at <http://www.ums-gaas.com> for exact package dimensions.

It is strongly recommended to ground all pins marked "Gnd" through the PCB board. Ensure that the PCB board is designed to provide the best possible ground to the package.

Definition of the Sij reference planes

The reference planes used for Sij measurements given above are symmetrical from the symmetrical axis of the package (see drawing beside). The input and output reference planes are located at 3.18mm offset (input wise and output wise respectively) from this axis. Then, the given Sij parameters incorporate the land pattern of the evaluation motherboard recommended in paragraph "Evaluation motherboard".

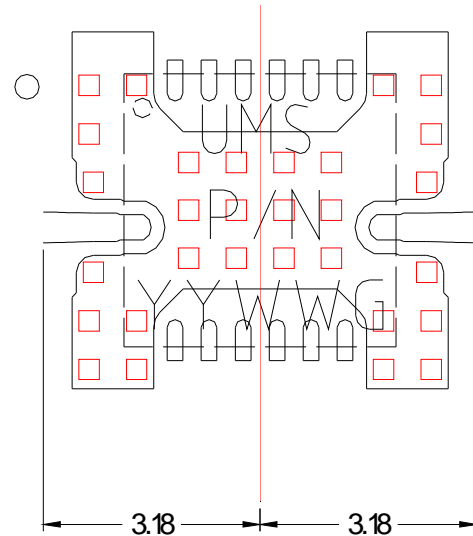

Recommended package footprint

Refer to the application note AN0017 available at <http://www.ums-gaas.com> for package foot print recommendations.

SMD mounting procedure

The SMD leadless package has been designed for high volume surface mount PCB assembly process. The dimensions and footprint required for the PCB (motherboard) are given in the drawings above.

For the mounting process standard techniques involving solder paste and a suitable reflow process can be used. For further details, see application note AN0017.

Recommended environmental management

Refer to the application note AN0019 available at <http://www.ums-gaas.com> for environmental data on UMS package products.

Note

Due to ESD protection circuits on RF input and output, an external capacitance might be requested to isolate the product from external voltage that could be present on the RF accesses.

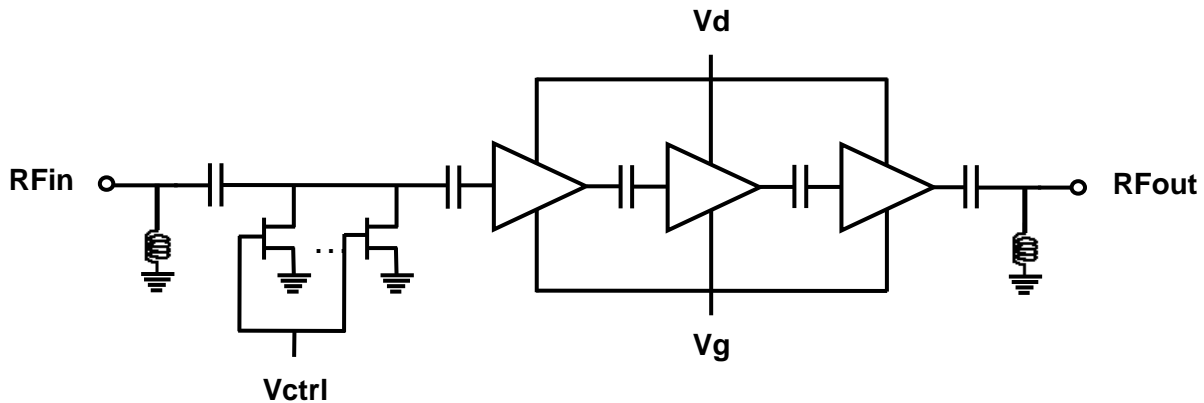

ESD protections are also implemented on gate and control accesses. The DC connections do not include any decoupling capacitor in package, therefore it is mandatory to provide a good external DC decoupling (10nF) on the PC board, as close as possible to the package.

Refer to the application note AN0020 available at <http://www.ums-gaas.com> for ESD sensitivity and handling recommendations for the UMS package products.

Evaluation mother board:

- Compatible with the proposed footprint.
- Based on typically Ro4003 / 8mils or equivalent.
- Using a microstrip to coplanar transition to access the package.
- Recommended for the implementation of this product on a module board.
- Decoupling capacitors of 10nF \pm 10% are recommended for all DC accesses.
- (See application note AN0017 for details).

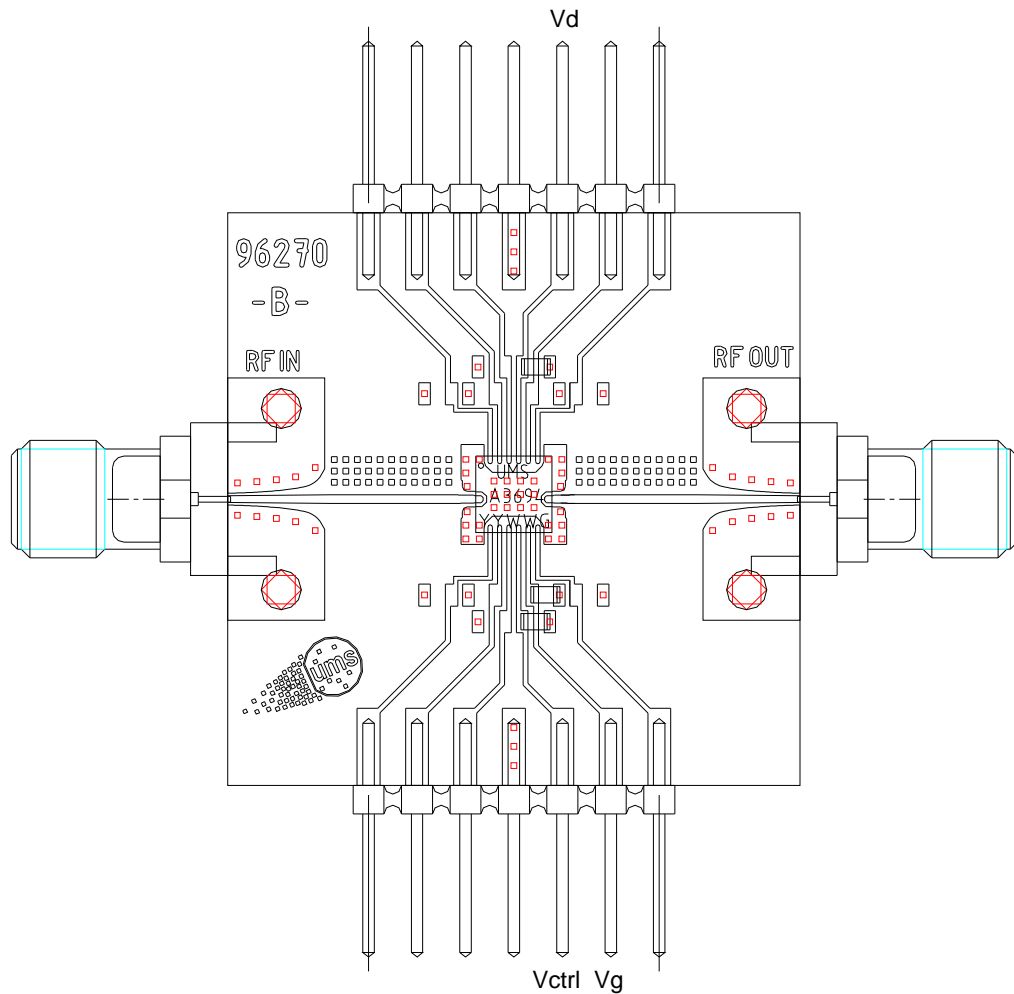

Ordering Information

QFN 4x4 RoHS compliant package: CHA3694-QDG/XY
Stick: XY = 20 Tape & reel: XY = 21

Information furnished is believed to be accurate and reliable. However **United Monolithic Semiconductors S.A.S.** assumes no responsibility for the consequences of use of such information nor for any infringement of patents or other rights of third parties which may result from its use. No license is granted by implication or otherwise under any patent or patent rights of **United Monolithic Semiconductors S.A.S.** Specifications mentioned in this publication are subject to change without notice. This publication supersedes and replaces all information previously supplied. **United Monolithic Semiconductors S.A.S.** products are not authorised for use as critical components in life support devices or systems without express written approval from **United Monolithic Semiconductors S.A.S.**

Ref. : DSCHA3694QDG9322 - 18 Nov 09

16/16

Specifications subject to change without notice