

5 – 18 GHz High Power Amplifier

GaAs Monolithic Microwave IC

Preliminary

Description

The **CHA6518** is a monolithic three-stage GaAs high power amplifier designed for wide band applications.

This device is manufactured using a UMS 0.25 μm Power pHEMT process, including, via holes through the substrate and air bridges.

To simplify the assembly process:

- the backside of the chip is both RF and DC grounded
- bond pads and back side are gold plated for compatibility with eutectic die attach method and thermosonic or thermocompression bonding process.

Main Features

- 0.25 μm Power pHEMT Technology
- 5 – 18 GHz Frequency Range
- 2W Output Power
- 24 dB nominal Gain
- Quiescent Bias point : 8V ; 1A
- Chip size: 5.23 mm x 3.26 mm x 0.07 mm

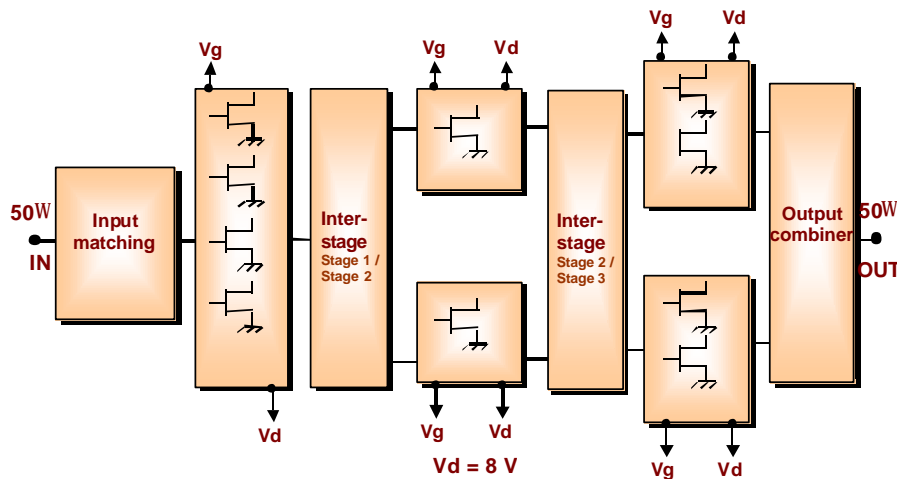

Main Characteristics

$T_{amb} = +25^{\circ}\text{C}$ (T_{amb} is the back-side of the chip)

Symbol	Parameter	Min	Typ	Max	Unit
F _{op}	Operating frequency range	5		18	GHz
P _{sat}	Saturated output power		33.5		dBm
G _{lin}	Linear gain		24		dB

Electrical Characteristics

Tamb = 25°C (2), Vd=8V, Ic (Quiescent) = 1A, CW biasing mode

Symbol	Parameter	Min	Typ	Max	Unit
F_op	Operating frequency	5		18	GHz
G_lin_1	Linear gain	20	24		dB
G_lin_T	Linear gain variation versus temperature		-0.045		dB/°C
RL_in	Input Return Loss	5.5	10		dB
RL_out	Output Return Loss	3.5	10		dB
P_sat_1	Saturated output power (5 to 6 GHz)	32.5	33		dBm
P_sat_2	Saturated output power (6 to 7 GHz)	33	34		dBm
P_sat_3	Saturated output power (8 to 10 GHz)	32.5	33		dBm
P_sat_4	Saturated output power (11 to 12 GHz)	32	32.5		dBm
P_sat_5	Saturated output power (13 to 14 GHz)	32.5	33		dBm
P_sat_6	Saturated output power (15 to 17 GHz)	33	34		dBm
P_sat_7	Saturated output power (18 GHz)	32	32.5		dBm
PAE_sat	Power Added Efficiency in saturation	11	20		%
Vd	Positive supply voltage		8		V
Id	Power supply quiescent current (1)		1		A
Vg	Negative supply voltage		-0.8		V
Top	Operating temperature range (2)	-30		+80	°C
NF	Noise Figure		5		dB

(1) This parameter is fixed by gate voltage Vg

(2) The reference is the back-side of the chip

Absolute Maximum Ratings (1)

Symbol	Parameter	Values	Unit
Pin (2)	Input continuous power	17	dBm
Vd (2)	Positive supply voltage without RF power	9	V
Id (2)	Positive supply quiescent current	1.5	A
I _g (2)	Gate supply current	88	mA
Pd (2)	Power dissipation	13.5	W
T _j	Junction temperature	175	°C
Tstg	Storage temperature range	-55 to +125	°C

(1) Operation of this device above any one of these parameters may cause permanent damage.

(2) These values are specified for Tamb = 25°C

Typical measured characteristics

Measurements in test fixture :

Tamb=25°C, Vd=8V, Id (Quiescent) = 1A, CW Biasing mode, Pin=13dBm

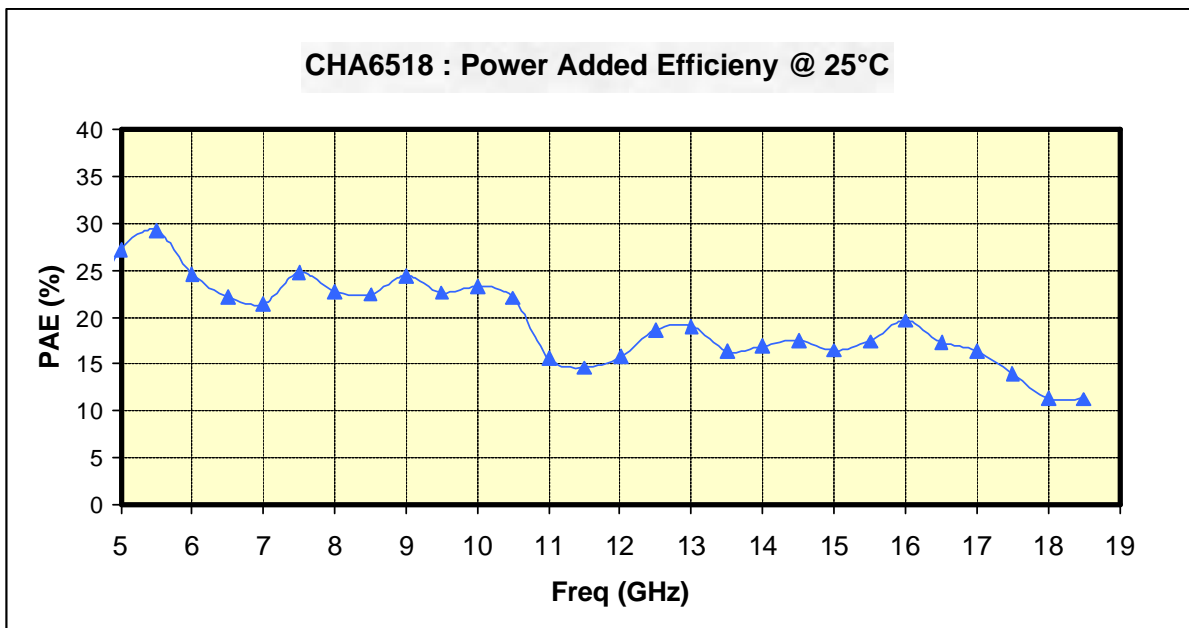
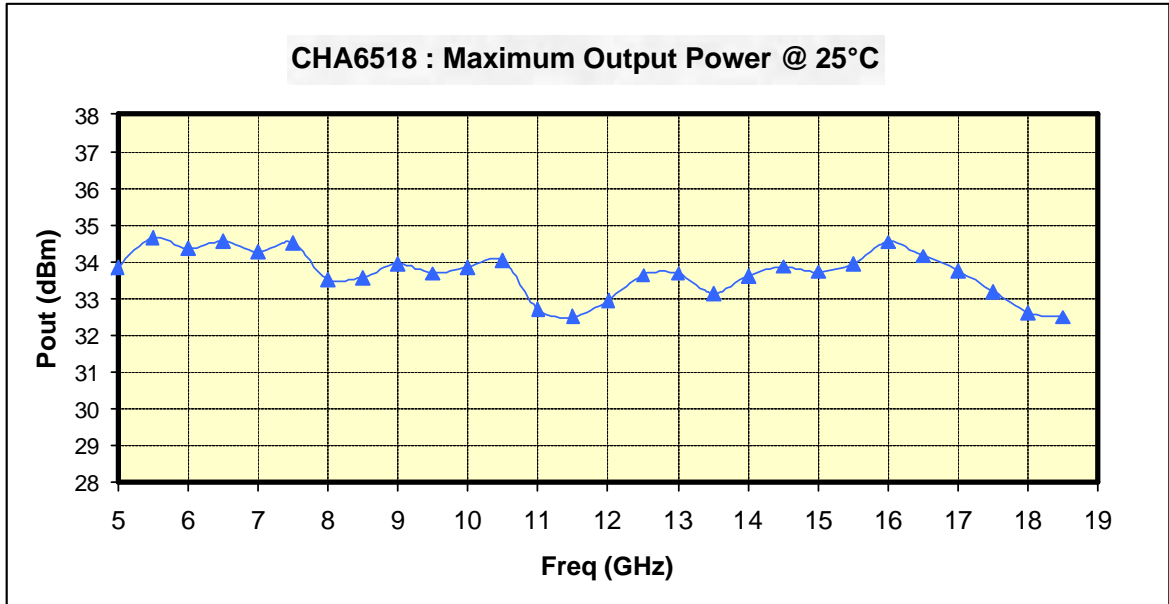

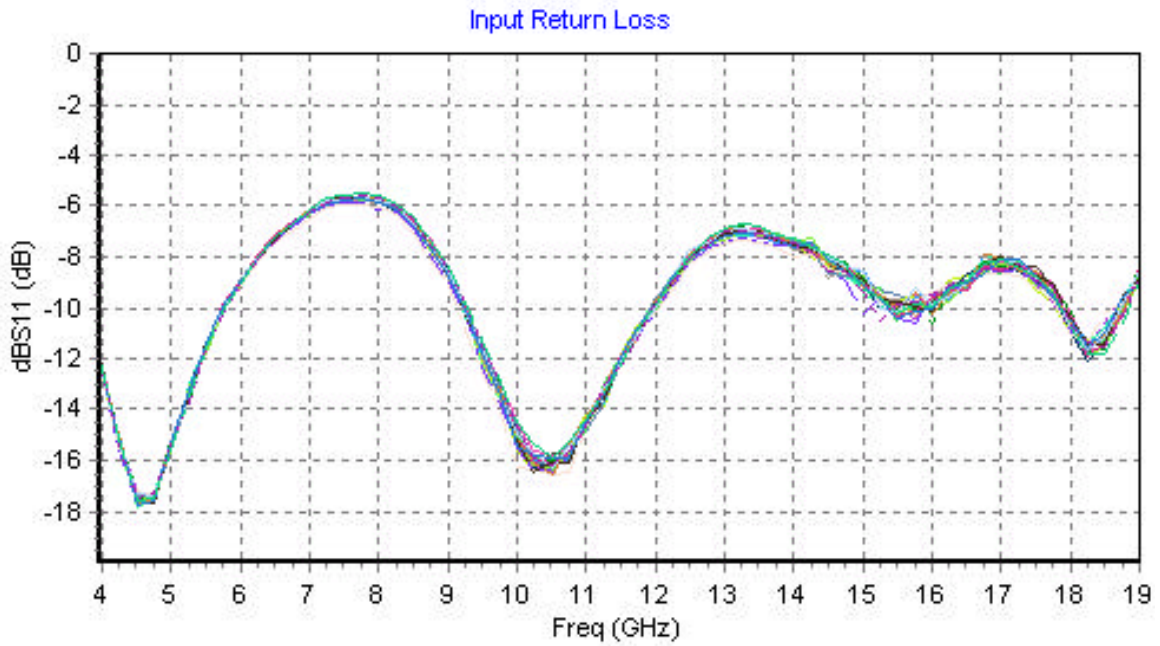
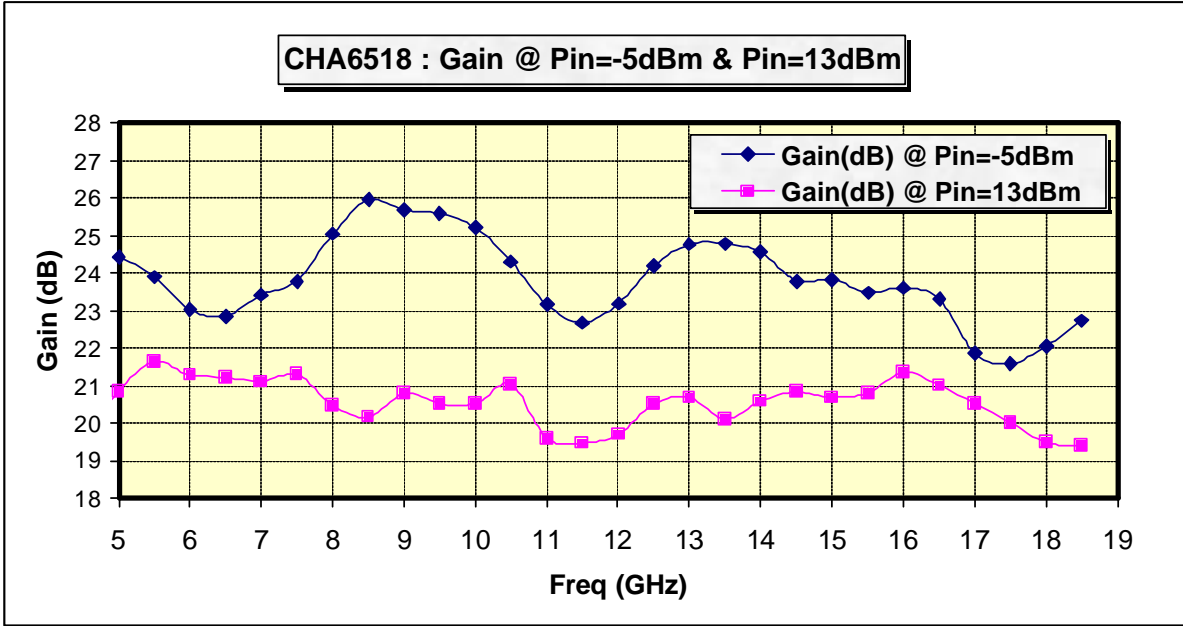

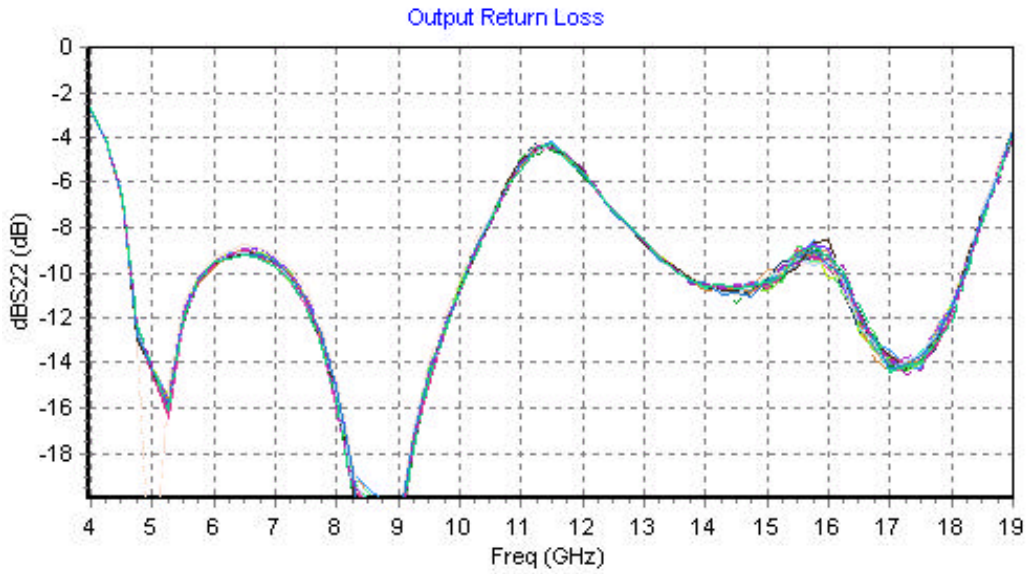

CHA6518 : Noise Figure @ 25°C

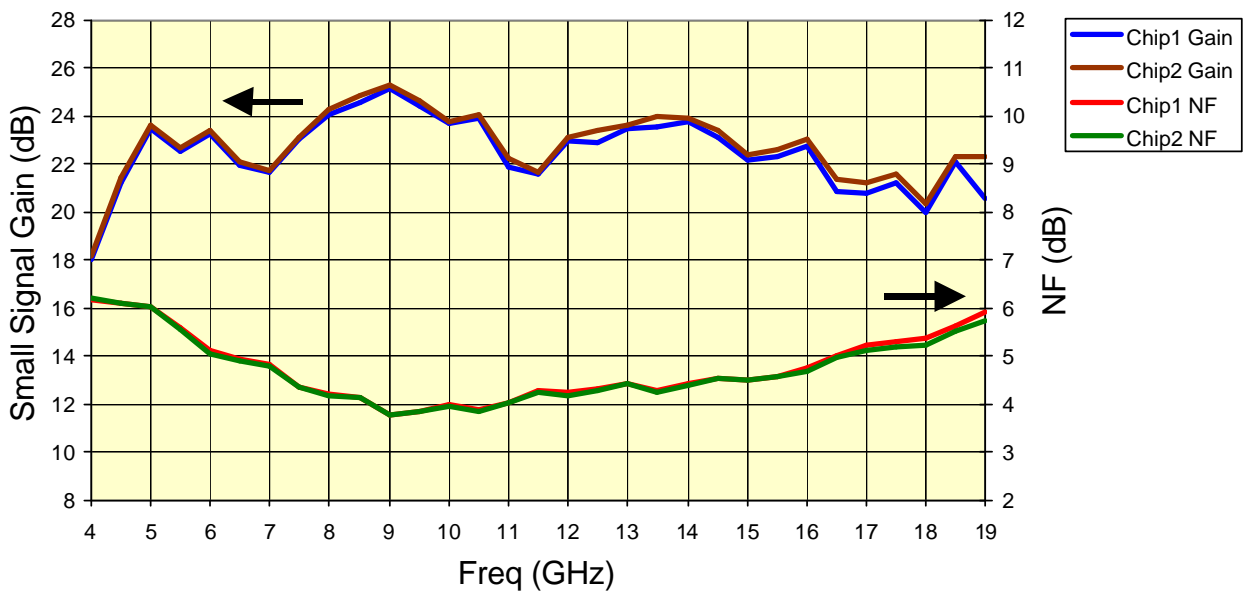

Chip Mechanical Data and Pin references

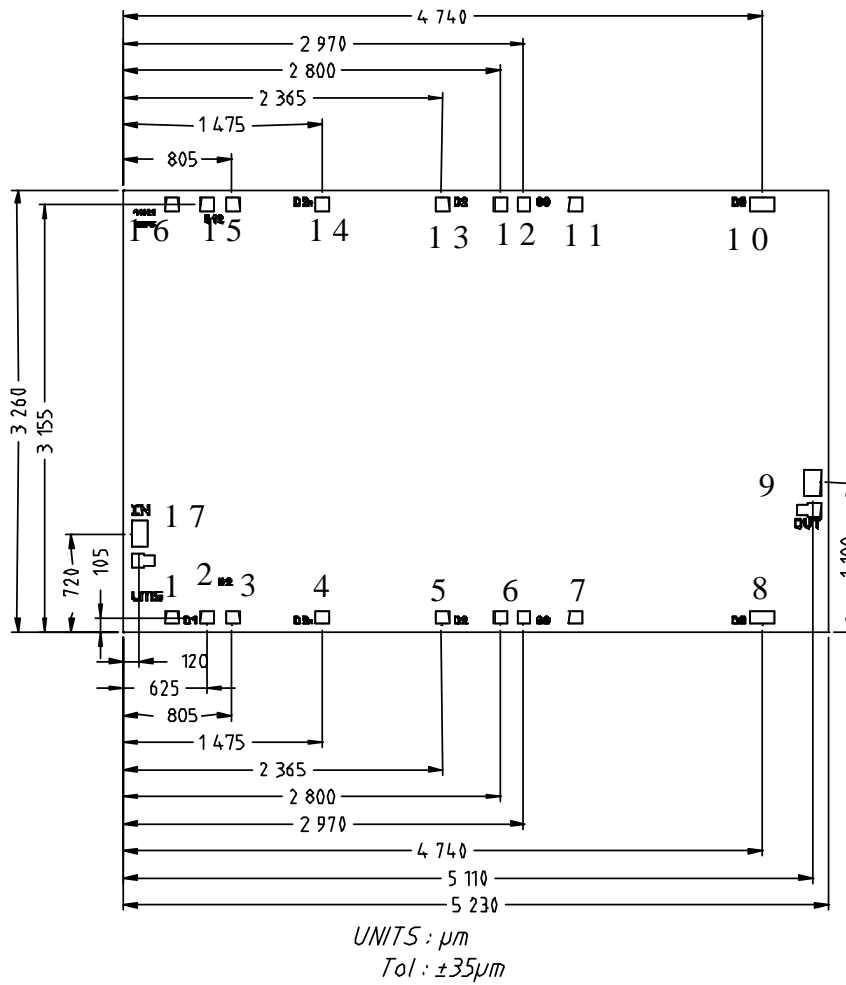

- Chip thickness = $70\mu\text{m} \pm 10\mu\text{m}$
- HF pads (9, 17) = 118×196
- DC pads (2, 3, 4, 5, 13, 14) = 96×96
- DC pads (6, 12) = 268×96
- DC pads 15 = 280×96
- DC pads (8, 10) = 188×96

Pin number	Pin name	Description
17	IN	Input RF port
4, 14		NC
3, 6, 12, 15	VG	Negative supply voltage
1, 7, 11, 16	GND	Ground (NC)
2, 5, 8, 10, 13	VD	Positive supply voltage
9	OUT	Output RF port

Assembly recommendations

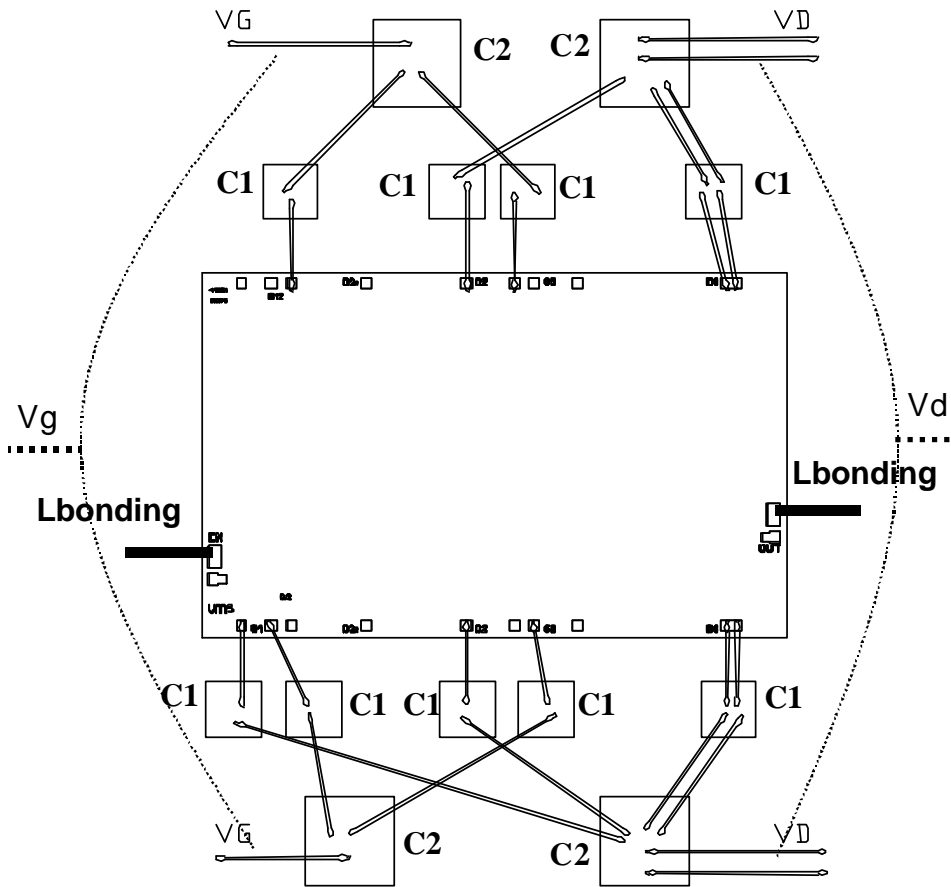

For thermal and electrical considerations, the chip should be brazed on a metal base plate. The RF, DC and modulation port inter-connections should be done according to the following table:

Port	Connection	External capacitor
IN (17)	Inductance (Lbonding) = 0.3nH	
OUT (9)	Inductance (Lbonding) = 0.3nH	
VD (2, 5, 8, 10, 13)	Inductance ≤ 1nH	C1 ~ 100pF C2 ~ 100nF
VG (3, 6, 12, 15)	Inductance ≤ 1nH	C1 ~ 100pF C2 ~ 100nF

Ordering Information

Chip form : CHA6518-99F/00

Information furnished is believed to be accurate and reliable. However **United Monolithic Semiconductors S.A.S.** assumes no responsibility for the consequences of use of such information nor for any infringement of patents or other rights of third parties which may result from its use. No license is granted by implication or otherwise under any patent or patent rights of **United Monolithic Semiconductors S.A.S.**. Specifications mentioned in this publication are subject to change without notice. This publication supersedes and replaces all information previously supplied. **United Monolithic Semiconductors S.A.S.** products are not authorised for use as critical components in life support devices or systems without express written approval from **United Monolithic Semiconductors S.A.S.**