

X-band High Power Amplifier

Preliminary

GaAs Monolithic Microwave IC

Description

The CHA7215 is a monolithic three-stage GaAs high power amplifier designed for X band applications.

The HPA provides typically 9W output power associated to 36% power added efficiency at 4dBc and a high robustness on mismatch load.

This device is manufactured using 0.25 μm Power pHEMT process, including, via holes through the substrate and air bridges.

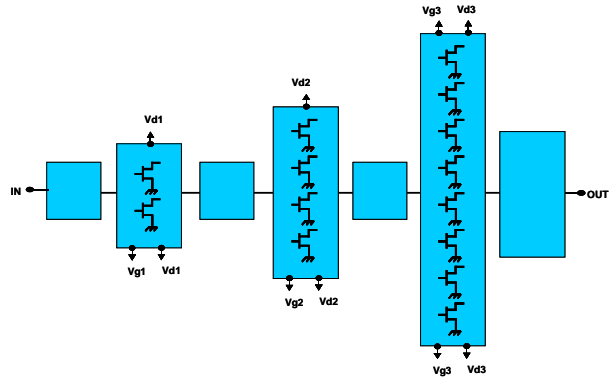

Main Features

- 0.25 μm Power pHEMT Technology
- Frequency band: 8.5 – 11.5GHz
- Output power: 39.5dBm @ 4dBc
- High linear gain: 28.5dB
- Power added efficiency: 36% @4dBc
- Quiescent bias point: $V_d=8\text{V}$, $I_d=2.3\text{A}$
- Chip size: 5 x 3.31 x 0.07mm

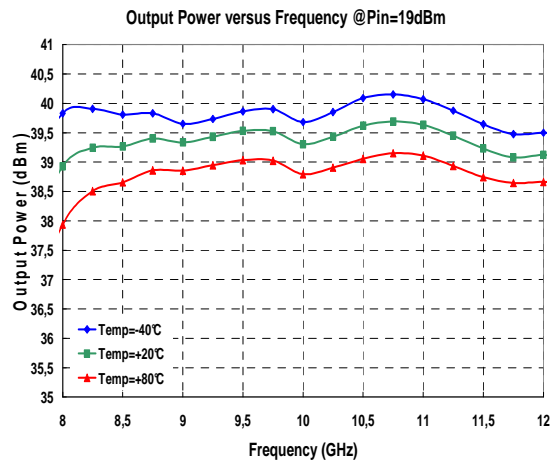

Main Characteristics

$V_d=8\text{V}$, I_d (Quiescent) = 2.3A, Drain Pulse width = 25 μs , Duty cycle = 10%

Symbol	Parameter	Min	Typ	Max	Unit
Top	Operating temperature range	-40		+80	°C
Fop	Operating frequency range	8.5		11.5	GHz
PAE_4dBc	Power added efficiency @4dBc @ 20°C		36		%
P_4dBc	Output power @ 4dBc @ 20°C		39.5		dBm
G	Small signal gain @ 20°C		28		dB

ESD Protections: Electrostatic discharge sensitive device. Observe handling precautions!

Preliminary

Electrical Characteristics on test fixture

Tamb = 20°C, Vd=8V, Id (Quiescent) = 2.3A, Drain Pulse width = 25µs, Duty cycle = 10%

Symbol	Parameter	Min	Typ	Max	Unit
Fop	Operating frequency	8.5		11.5	GHz
G	Small signal gain		28		dB
G_T	Small signal gain variation versus temperature		-0.05		dB/°C
RLin	Input Return Loss		10		dB
RLout	Output Return Loss		12		dB
Psat	Saturated output power		39.6		dBm
Psat_T	Saturated output power variation versus temperature		-0.01		dB/°C
P_4dBc	Output power @ 4dBc		39.5		dBm
PAE_4dBc	Power added efficiency @4dBc 8.5GHz<Freq<10GHz 10GHz<Freq<11.5GHz		35		%
			33		%
Id_4dBc	Supply drain current @ 4dBc		3.4		A
Vd1, Vd2, Vd3	Drain supply voltage (2)		8		V
Id	Supply quiescent current (1)		2.3		A
Vg1, Vg2, Vg3	Gate supply voltage		-2		V

(1) Parameter can be adjusted by tuning of Vg.

(2) 0.5V variation on Vd leads to around 0.4dB variation of the output power (impact on robustness see Maximum ratings)

Absolute Maximum Ratings (1)

Tamb = 20°C

Symbol	Parameter	Values	Unit
Cmp	Compression level (2)	6	dBc
Vd	Supply voltage (3)	10	V
Id	Supply quiescent current	3	A
Id_sat	Supply current in saturation	4.5	A
Vg	Supply voltage	-1.1	V
Tj	Maximum junction temperature	175	°C
Tstg	Storage temperature range	-55 to +125	°C
Top	Operating temperature range	-40 to +80	°C

(1) Operation of this device above any one of these parameters may cause permanent damage.

(2) For higher compression the level limit can be increased by decreasing the voltage Vd using the rate 0.5 V / dBc

(3) Without RF input power

Typical measured characteristics

Preliminary

Measurements on Jig:

Vd=8V, Id (Quiescent) = 2.3A, Drain Pulse width = 25µs, Duty cycle = 10%

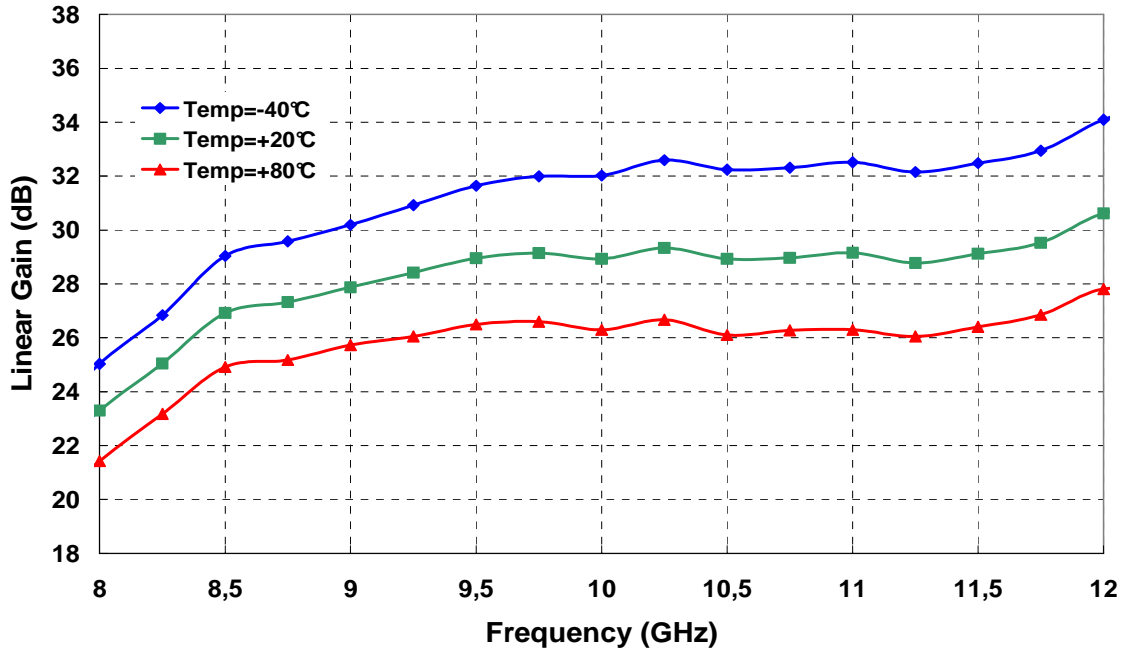

Linear gain versus frequency and temperature

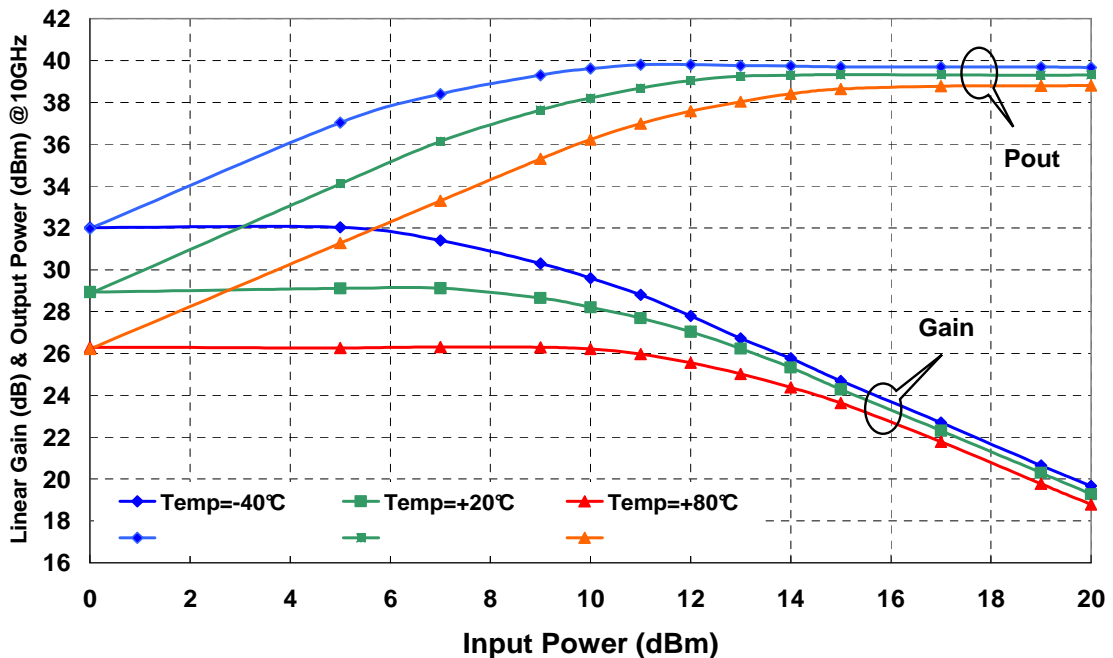

Linear Gain and Output Power @ Freq=10GHz versus input power and temperature

Preliminary

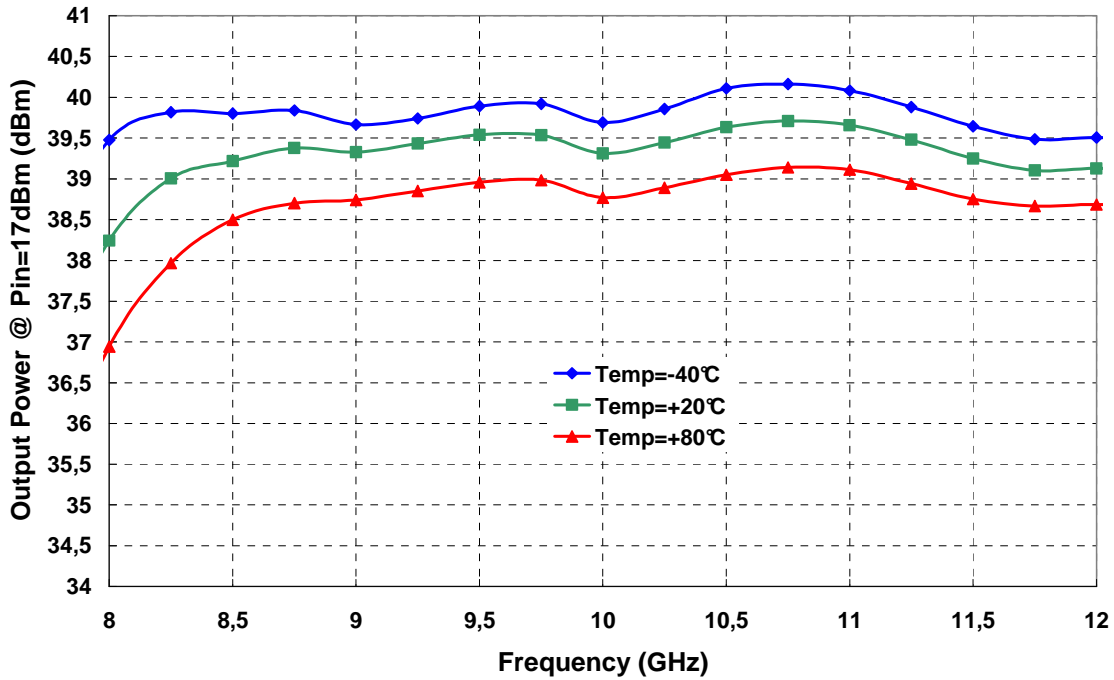

Output Power @Pin=17dBm versus frequency and temperature

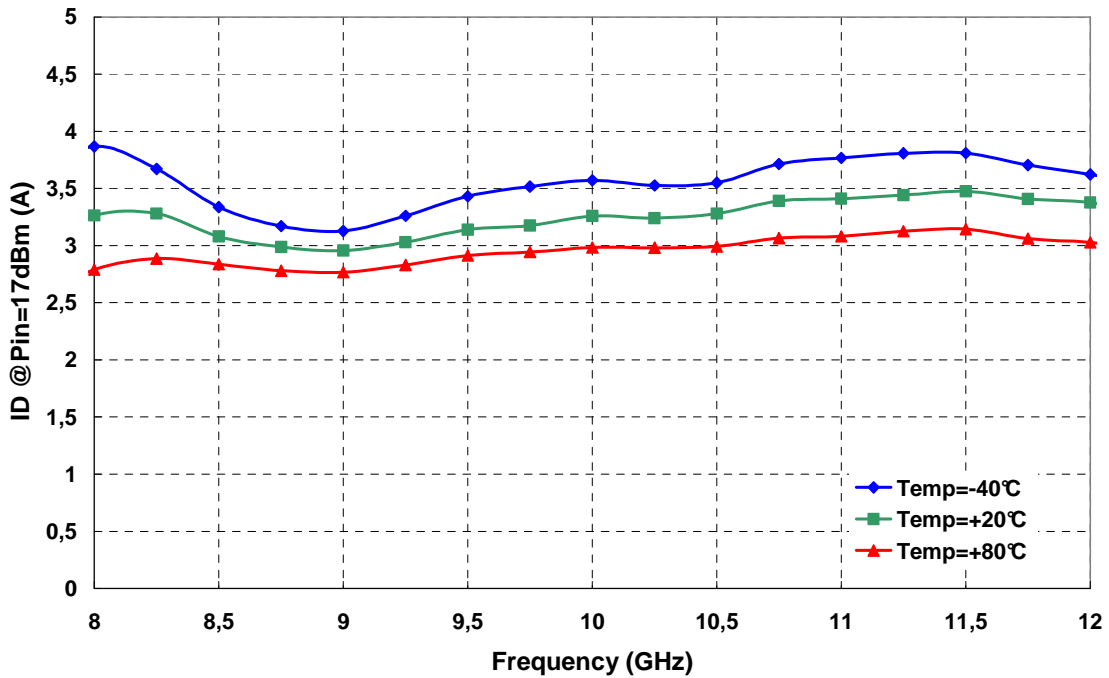

Id @Pin=17dBm versus frequency and temperature

Preliminary

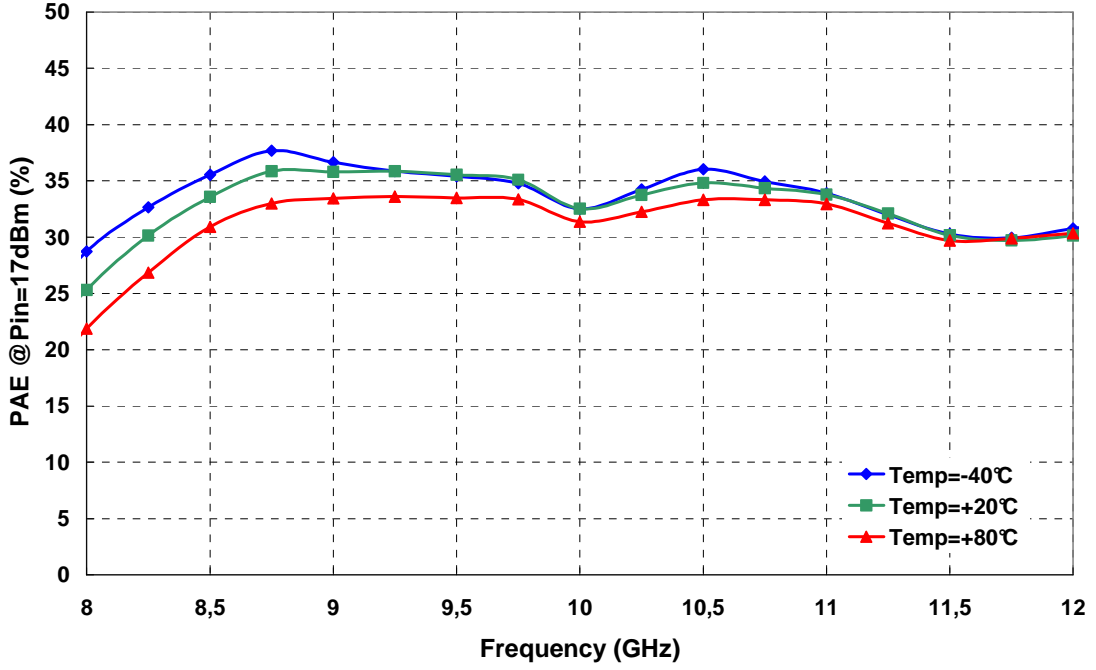

PAE @Pin=17dBm versus frequency and temperature

Preliminary

Chip Mechanical Data and Pin references

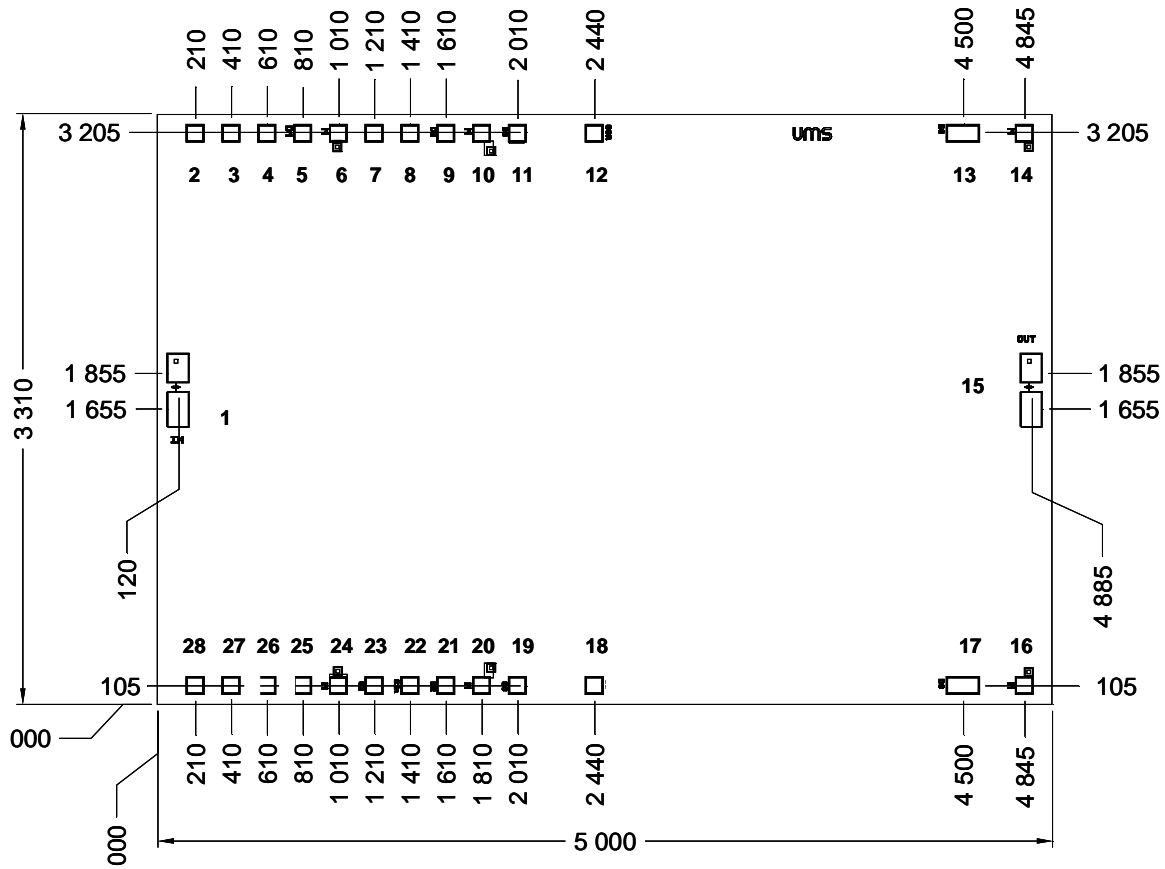

UNITS : μm
Tol : $\pm 35\mu\text{m}$

Chip thickness = $70\mu\text{m} \pm 10\mu\text{m}$
 RF pads (1, 15) = $122 \times 200\mu\text{m}^2$
 DC pads (2 to 12, 14, 16, 18 to 28) = $100 \times 100\mu\text{m}^2$
 DC pads (13, 17) = $186 \times 100\mu\text{m}^2$

Pin number	Pin name	Description
1, 15	IN / OUT	Input / Output RF
3, 8, 12, 18	GxR	Gate supply voltage
4, 6, 10, 14, 16, 20, 24, 26	M	Ground (Not connected)
5, 9, 13, 17, 21, 25	Dx	Drain supply voltage
2, 7, 11, 19, 22, 23, 27, 28	Gx / GxR	Not connected

Preliminary

Bonding recommendations

Port	Connection	External capacitor
IN	Inductance (L _{bonding}) = 0.35nH 2 gold wires with diameter of 25 μm (600μm max)	
OUT	Inductance (L _{bonding}) = 0.35nH 2 gold wires with diameter of 25 μm (600μm max)	
Vg	Inductance ≤ 1nH	C1 ~ 100pF C2 ~ 10nF
Vd	Inductance ≤ 1nH	C1 ~ 100pF

Assembly recommendations in test fixture

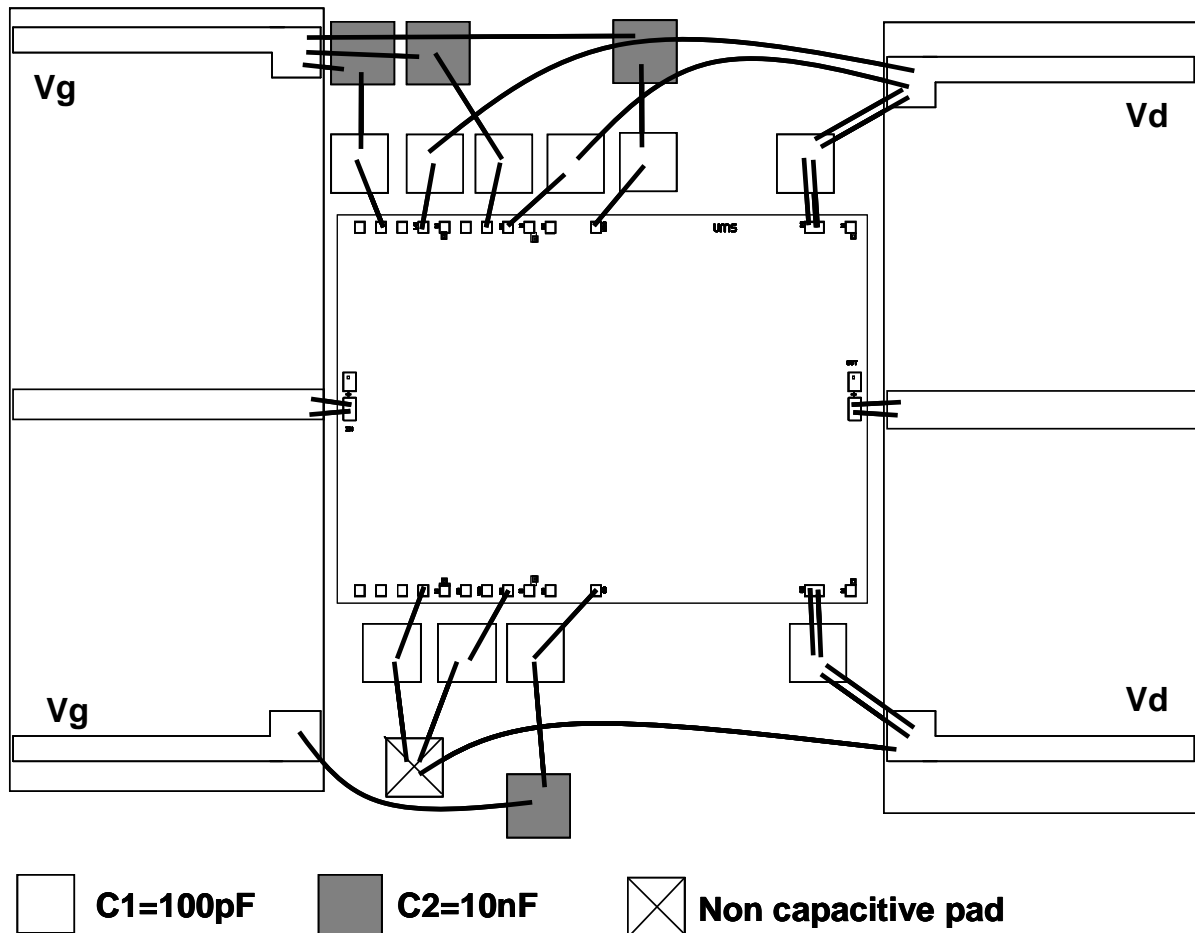

Ordering Information

Chip form : CHA7215-99F/00

Information furnished is believed to be accurate and reliable. However **United Monolithic Semiconductors S.A.S.** assumes no responsibility for the consequences of use of such information nor for any infringement of patents or other rights of third parties which may result from its use. No license is granted by implication or otherwise under any patent or patent rights of **United Monolithic Semiconductors S.A.S.** Specifications mentioned in this publication are subject to change without notice. This publication supersedes and replaces all information previously supplied. **United Monolithic Semiconductors S.A.S.** products are not authorised for use as critical components in life support devices or systems without express written approval from **United Monolithic Semiconductors S.A.S.**